

**SANNOHM™**

# THROUGH-HOLE RESISTOR BUYER'S GUIDE

**SANYO-OHM™**

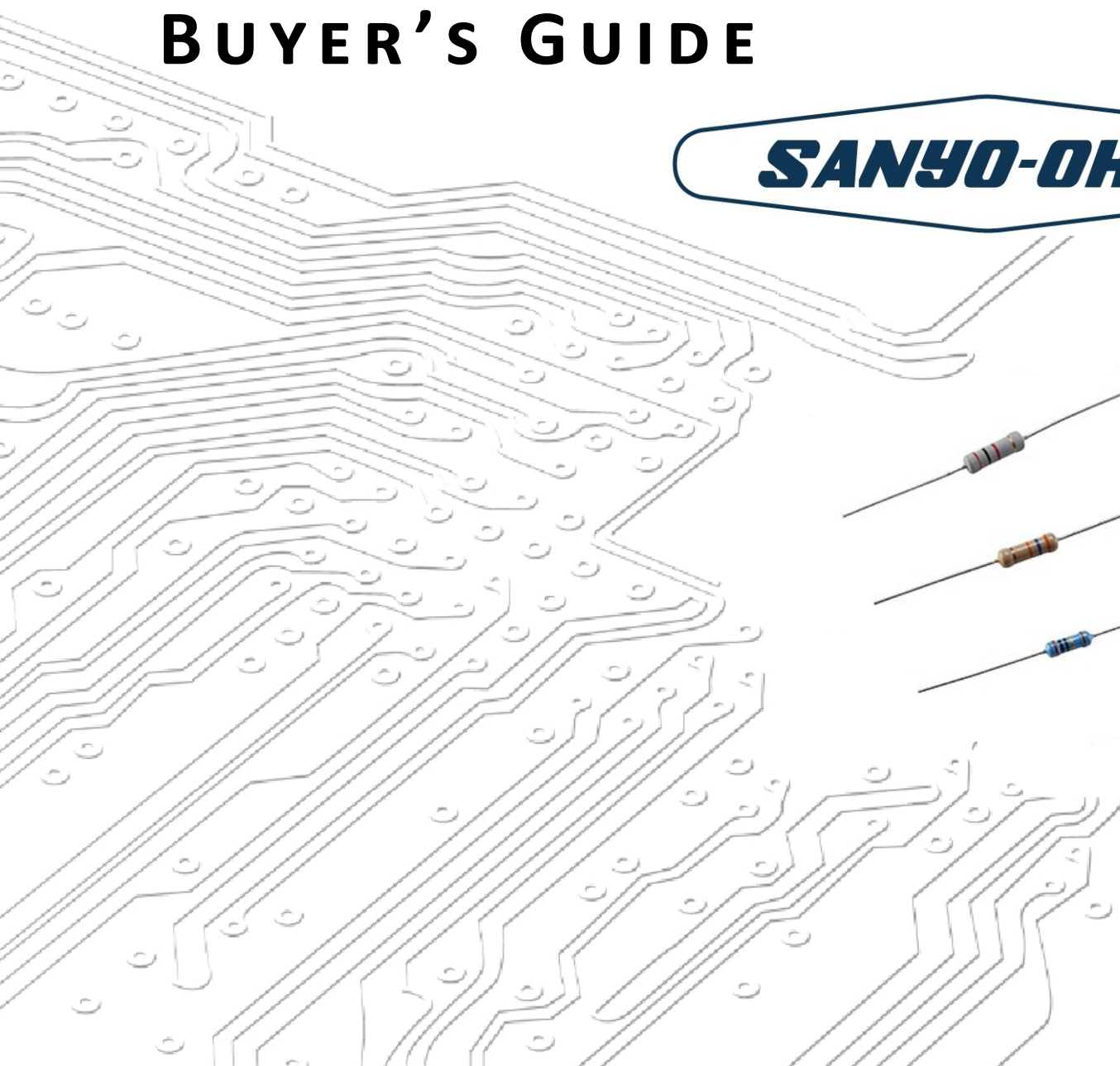

**SP**international

S-P International offers a complete line of resistor products to meet all customer requirements, in both SMD and through-hole styles under our Sannohm and Sanyo-OHM brand names. For over 45 years, Canadian and world-wide manufacturers have come to depend on S-P International's Sannohm and Sanyo-OHM brand resistors. From the basic 5% carbon film resistor to tight tolerance metal film resistor; with wattages from ranging from 1/8W to 500W, we have the right resistor for your requirements.

S-P International draws on the expertise of the world's major resistor suppliers to bring you the right products at the right prices. Please note that not all products are carried in stock and some are subject to minimum order quantities. We have listed the most popular items in each category, Carbon Film, Metal Film, Metal Oxide, Metal Glazed, Wire Wound, and SIP. Contact the S-P International office near you, or your local distributor with your requirements for complete specifications and pricing.



S-P International - Burnaby  
Corporate Head Office and Warehouse



S-P International - Markham  
Sales Office - Eastern Region



	<p>S-P International's Sannohm and Sanyo-OHM resistors are fully RoHS &amp; REACH Compliant as well as meeting all Conflict Minerals Report requirements. Leads are matte tin plated. For further information on S-P International's RoHS compliant products, please contact your local distributor or contact S-P International directly.</p>	
--	--	--



SANNOHM and SANYO-OHM are trademarks of S-P International

NOTICE:  
Data given in the publication is subject to product improvement change without prior notification.  
Certain products listed in this publication are subject to factory minimum production requirements.

# Contents

Resistor Series	Resistor Type	Page
RNE Series	Metal Film Resistors	04
RNM Series	Miniature Metal Film Resistors	06
RSFxB Series	Metal Oxide Resistors	08
RSFxS Series	Miniature Metal Oxide Resistors	10
FM020x Series	Professional Resistors - Flameproof	12
MF020x Series	Professional Resistors	14
MO Series	Super-Mini Metal Oxide Resistors	16
MG Series	Metal Glazed Resistors	18
SURC Series	Anti-Surge Resistors	20
SURM Series	Anti-Surge Resistors	22
MF / FMF Series	Metal Film Resistors	24
RNF Series	Fusible Metal Film Resistors	26
RNFM Series	Miniature Fusible Metal Film Resistors	27
RD OR	Zero Ohm Resistors	29
RD Series	Carbon Film Resistors	30
RDM Series	Miniature Carbon Film Resistors	32
RDF Series	Flameproof Carbon Film Resistors	34
SSR Series	Surge Safety Resistors	36
JPW Series	Jumper Wire	38
SN Series	SIP Resistor Networks	40
SQP (NSP) Series	Cement - Axial Lead Resistors	42
SQM (NSM) Series	Cement - Radial Lead Resistors	44
SQM (NSM) Series mini	Cement - Mini Radial Lead Resistors	46
SQF Series	Power Rectangular Low Resistance	48
KNP Series	Wire Wound Resistors	50
KNPxWS Series	Miniature Wire Wound Resistors	52
MR Series	Custom Milliohm Resistor	54
TR Series	TO-220 Power Resistors	56
TR100 Series	TO-247 Power Resistors	58
AH Series	Aluminum Power Resistors	60
CH Series	Tubular Power Wire Wound Resistors	62
	Packaging and Taping Specifications	64
	Lead Forming and Taping Specifications	66
	Resistance Tables	69

**NEW**

# RNE Metal Film Resistor

- LOW NOISE
- LOW TCR 100ppm, 50ppm, 25ppm
- HIGH PRECISION 1%, 0.5%, 0.25%, 0.1%

## POWER RATING

1/8W ~ 2W

## DIMENSIONS

Body Colour: Light Blue

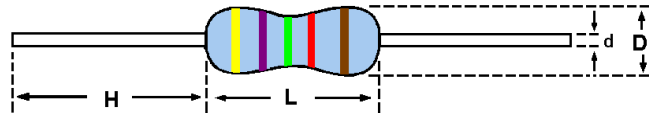

STYLE	DIMENSIONS (mm)			
	L	D	H	d
RNE18	3.3 + 0.7—0.2	1.8 ± 0.3	29 ± 2.0	0.45 ± 0.03
RNE14	6.3 ± 0.5	2.3 ± 0.3	28 ± 2.0	0.55 ± 0.03
RNE12	9.0 ± 0.5	3.2 ± 0.5	26 ± 2.0	0.65 ± 0.03
RNE1	11.5 ± 1.0	4.5 ± 0.5	35 ± 2.0	0.78 ± 0.03
RNE2	15.5 ± 1.0	5.0 ± 0.5	32 ± 2.0	0.78 ± 0.03

## ELECTRICAL CHARACTERISTICS

Power Rating at 70°C	0.125 W	0.25 W	0.5 W	1 W	2 W
STYLE	RNE18	RNE14	RNE12	RNE1	RNE2
Operating Temp. Range	-55°C ~ +155°C				
Maximum Working Voltage	200V	250V	350V	450V	500V
Maximum Overload Voltage	400V	500V	700V	1000V	1000V
Dielectric Withstanding Volt.	300V	500V	500V	1000V	1000V
Temperature Coefficient	±15ppm/°C, ±25ppm/°C, ±50ppm/°C, ±100ppm/°C				
Value Range ±1% ±0.5%*	10Ω ~ 1MΩ				
Value Range ±0.25% ±0.1%*	100Ω ~ 100KΩ				

\*Resistance range for standard resistance – below or over this resistance on request.

## POWER DERATING CURVE

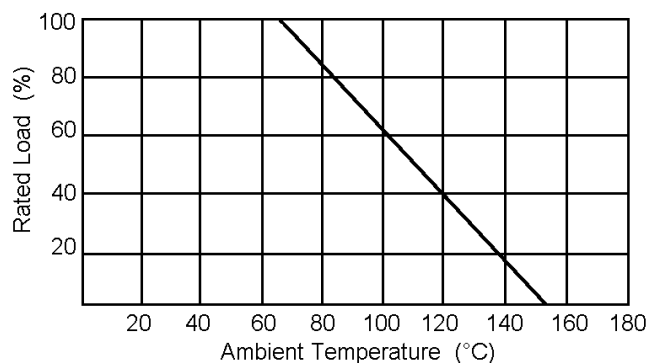

## HOT-SPOT TEMPERATURE

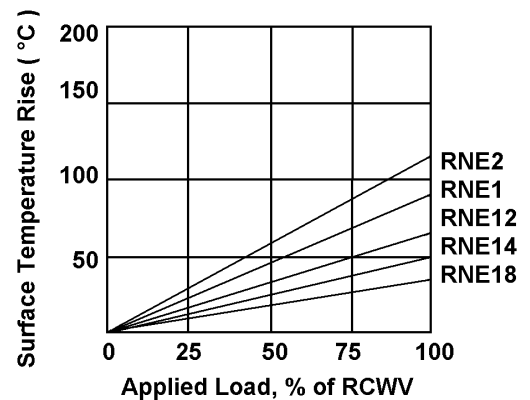

### PERFORMANCE CHARACTERISTICS

PERFORMANCE TEST	TEST METHOD	APPRAISE
Short Time Overload	JIS-C5202 5.5 2.5 times RCWV for 5 seconds	± (0.25% + 0.05Ω)
Temperature Coefficient (TCR)	Resistance value at room temperature (+100°C)	By Type
Dielectric Withstanding Voltage	JIS-C5202 5.7 In V-Block for 60 seconds	By Type
Pulse Overload	JIS-C5202 5.8 4 x RCWV for 10,000 cycles (1 seconds on, 25 seconds off)	± (0.75% + 0.05Ω)
Insulation Resistance	JIS-C5202 5.6 In V-Block	> 10,000MΩ
Load Life	JIS-C5202 7.10 70°C at RCWV for 1,000 hrs (1.5 hr on, 0.5 hr off)	± (1.5% + 0.05Ω)
Load Life in Humidity	JIS-C5202 7.9 40 ± 2°C, 90 ~ 95%RH at RCWV for 1,000hrs (1.5 hr on, 0.5 hr off)	± (1.5% + 0.05Ω)
Solderability	JIS-C5202 6.5 235 ± 5°C for 2 ± 0.5 seconds	95% minimum coverage
Resistance to Solvent	JIS-C5202 6.9 Trichroethane for 1 min. with ultrasonic	No deterioration of coatings and markings
Terminal Strength	Direct load for 10 seconds In the Direction of the terminal leads	Tensile ≥ 2.5kg

Rated Continuous Working Voltage (RCWV) =  $\sqrt{\text{Power Rating} \times \text{Resistance Value}}$

### PART NUMBER

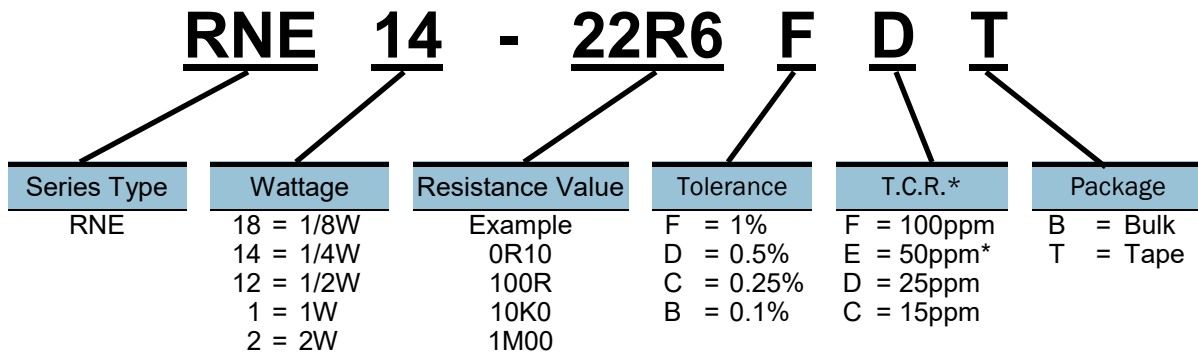

\*Note that unless otherwise stipulated, the standard supplied TCR on 1% tolerance resistors, 10R ~ 1M, is 50ppm. The "E" TCR code is not used when ordering the standard part. Example: RNE14-499RFT = 1/4W, 499Ω, 1%, 50ppm, Tape. The TCR code is used only when ordering a tolerance less than 1%, or when an TCR other than the standard is required.

### STANDARD PACKAGING

BULK	1/8W ~ 2W	200 pieces	TAPE	1/8W, 1/4W	5,000 pieces
				1/2W	3,000 pieces
				1W	2,000 pieces

RNE Series parts are  
RoHS & REACH Compliant

Storage Temperature: 25°C ± 3°C; Humidity < 80% RH

# RNM Mini-Metal Film Resistor

- LOW NOISE
- LOW TCR 100ppm, 50ppm, 25ppm
- HIGH PRECISION 1%, 0.5%, 0.25%, 0.1%

## POWER RATING

1/4W ~ 3W

## DIMENSIONS

Body Colour: Light Blue

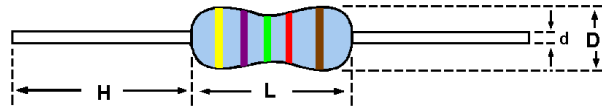

STYLE	DIMENSIONS (mm)			
	L	D	H	D
RNM14	3.3 + 0.7—0.2	1.8 ± 0.3	29 ± 2.0	0.45 ± 0.03
RNM12	6.3 ± 0.5	2.3 ± 0.3	28 ± 2.0	0.55 ± 0.03
RNM1	9.0 ± 0.5	3.2 ± 0.5	26 ± 2.0	0.65 ± 0.03
RNM2	11.5 ± 1.0	4.5 ± 0.5	35 ± 2.0	0.78 ± 0.03
RNM3	15.5 ± 1.0	5.0 ± 0.5	32 ± 2.0	0.78 ± 0.03

## ELECTRICAL CHARACTERISTICS

Power Rating at 70°C	0.25 W	0.5 W	1 W	2 W	3 W
STYLE	RNM14	RNM12	RNM1	RNM2	RNM3
Operating Temperature Range	-55°C ~ +155°C				
Maximum Working Voltage	200V	300V	400V	500V	500V
Maximum Overload Voltage	400V	600V	800V	1000V	1000V
Dielectric Withstanding Voltage	400V	500V	700V	1000V	1000V
Temperature Coefficient	50ppm/°C, ± 100ppm/°C				
Value Range ±1% ±0.5%*	10Ω ~ 1MΩ				

\*Resistance range for standard resistance – below or over this resistance on request.

## POWER DERATING CURVE

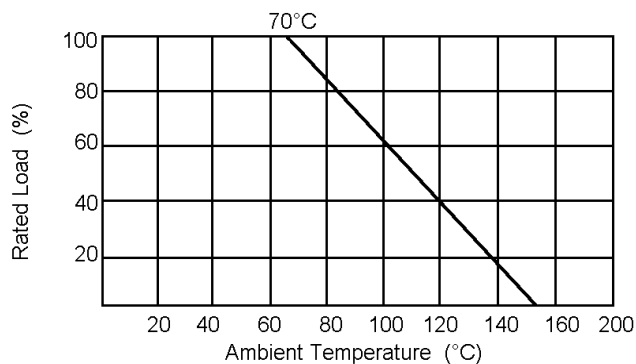

## HOT-SPOT TEMPERATURE

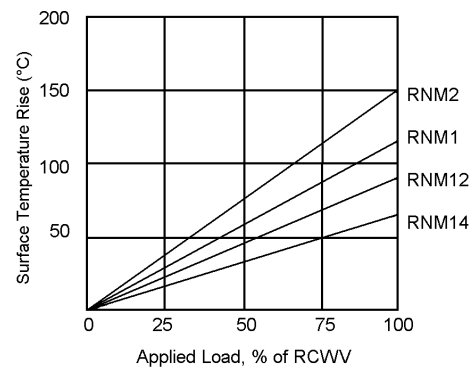

**PERFORMANCE CHARACTERISTICS**

PERFORMANCE TEST	TEST METHOD	APPRAISE
Short Time Overload	JIS-C5202 5.5 2.5 times RCWV for 5 seconds	±( 0.25% + 0.05Ω)
Temperature Coefficient (TCR)	Resistance value at room temperature (+100°C)	By Type
Dielectric Withstanding Voltage	JIS-C5202 5.7 In V-Block for 60 seconds	By Type
Pulse Overload	JIS-C5202 5.8 4 x RCWV for 10,000 cycles (1 seconds on, 25 seconds off)	± (0.75% + 0.05Ω)
Insulation Resistance	JIS-C5202 5.6 In V-Block	> 10,000MΩ
Load Life	JIS-C5202 7.10 70°C at RCWV for 1,000 hrs (1.5 hr on, 0.5 hr off)	± (1.5% + 0.05Ω)
Load Life in Humidity	JIS-C5202 7.9 40 ± 2°C, 90 ~ 95% RH at RCWV for 1,000 hrs (1.5 hr on, 0.5 hr off)	± (1.5% + 0.05Ω)
Solderability	JIS-C5202 6.5 235 ± 5°C for 2 ± 0.5seconds	95% minimum coverage
Resistance to Solvent	JIS-C5202 6.9 Trichroethane for 1 min. with ultrasonic	No deterioration of coatings and markings
Terminal Strength	Direct load for 10 seconds in the Direction of the terminal leads	Tensile ≥ 2.5kg

Rated Continuous Working Voltage (RCWV) =  $\sqrt{\text{Power Rating} \times \text{Resistance Value}}$

**PART NUMBER**

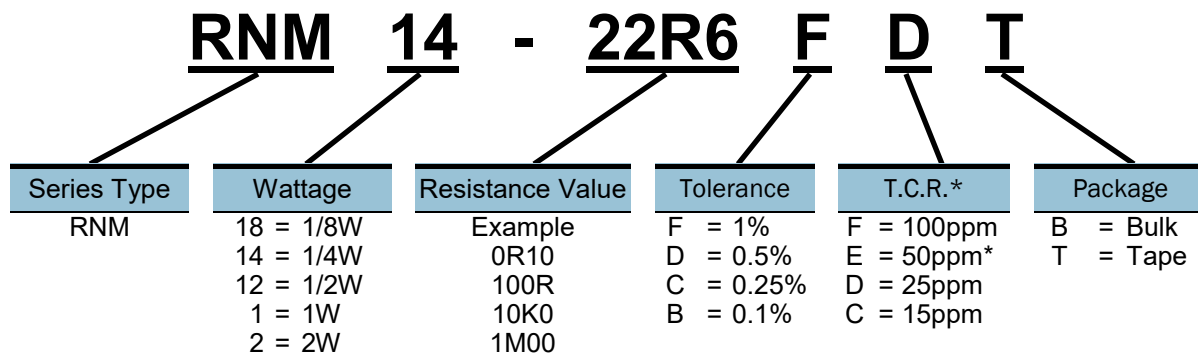

\*Note that unless otherwise stipulated, the standard supplied TCR on 1% tolerance resistors, 10R ~ 1M, is 50ppm. The "E" TCR code is not used when ordering the standard part. Example: RNM14-499RFT = 1/4W, 499W, 1%, 50ppm, Tape. The TCR code is used only when ordering a tolerance less than 1%, or when an TCR other than the standard is required.

**STANDARD PACKAGING**

BULK	1/4W ~ 3W	200 pieces	TAPE	1/4W, 1/2W	5,000 pieces
				1W	3,000 pieces
				2W	2,000 pieces
				3W	1,000 pieces

RNM Series parts are  
RoHS & REACH Compliant

Storage Temperature: 25°C ± 3°C; Humidity < 80% RH



# RSFxB Metal Oxide Resistor

- EXCELLENT LONG-TERM STABILITY
- COMPLETE FLAMEPROOF CONSTRUCTION UL-1412
- HIGH SURGE / OVERLOAD CAPABILITY
- WIDE RESISTANCE RANGE:  $0.1\Omega \sim 1M\Omega$
- RESISTANCE STANDARD TOLERANCE:  $\pm 5\%$  ( $\pm 2\%$ ,  $\pm 1\%$  AVAILABLE)
- NON-INDUCTIVE DESIGN, RESISTANCE RANGE:  $0.1\Omega \sim 100\Omega$

## POWER RATING

1/4W ~ 5W

## DIMENSIONS

Body Colour: Grey, Flameproof Coating

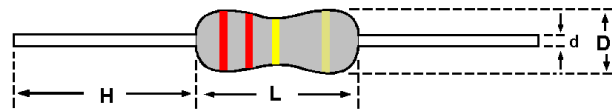

STYLE	DIMENSIONS (mm)			
	L	D	H	d
RSF14B	$6.3 \pm 0.5$	$2.3 \pm 0.3$	$28 \pm 2.0$	$0.55 \pm 0.03$
RSF12B	$9.0 \pm 0.5$	$3.2 \pm 0.5$	$26 \pm 2.0$	$0.65 \pm 0.03$
RSF1B	$11.5 \pm 1.0$	$4.5 \pm 0.5$	$35 \pm 2.0$	$0.78 \pm 0.03$
RSF2B	$15.5 \pm 1.0$	$5.0 \pm 0.5$	$32 \pm 2.0$	$0.78 \pm 0.03$
RSF3B	$17.5 \pm 1.0$	$6.5 \pm 0.5$	$35 \pm 2.0$	$0.78 \pm 0.03$
RSF5B	$24.5 \pm 1.0$	$8.5 \pm 0.5$	$35 \pm 2.0$	$0.78 \pm 0.03$

## ELECTRICAL CHARACTERISTICS

Power Rating at 70°C	0.25 W	0.5 W	1 W	2 W	3W	5W
STYLE	RSF14B	RSF12B	RSF1B	RSF2B	RSF3B	RSF5B
Operating Temperature Range	-55°C ~ +155°C					
Maximum Working Voltage	200V	250V	350V	350V	500V	750V
Maximum Overload Voltage	350V	400V	600V	600V	800V	1,000V
Dielectric Withstanding Volt.	350V	350V	500V	500V	700V	800V
Temperature Coefficient	0.1Ω~10Ω $\pm 200\text{ppm}/^\circ\text{C}$ ; 11Ω~51KΩ $\pm 300\text{ppm}/^\circ\text{C}$ ; 56KΩ~1MΩ $\pm 100\text{ppm}/^\circ\text{C}$					
Range $\pm 1\% \pm 2\% \pm 5\%*$	1Ω ~ 510KΩ					

\*Resistance range for standard resistance – below or over this resistance on request.

## POWER DERATING CURVE

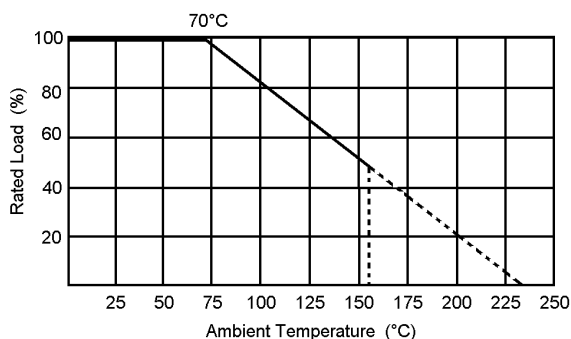

## HOT-SPOT TEMPERATURE

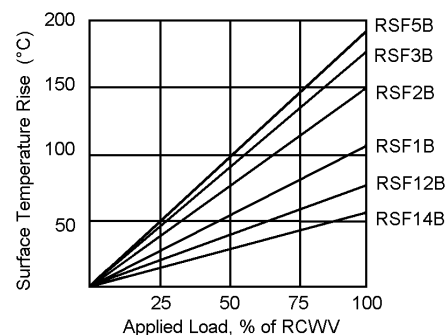



### PERFORMANCE CHARACTERISTICS

PERFORMANCE TEST	TEST METHOD	APPRAISE
Short Time Overload	JIS-C5202 5.5 2.5 times RCWV for 5 seconds	± (0.25% + 0.05Ω)
Temperature Coefficient (TCR)	Resistance value at room temperature (+100°C)	By Type
Dielectric Withstanding Voltage	JIS-C5202 5.7 In V-Block for 60 seconds	By Type
Pulse Overload	JIS-C5202 5.8 4 x RCWV for 10,000 cycles (1 seconds on, 25 seconds off)	± (1% + 0.05Ω)
Insulation Resistance	JIS-C5202 5.6 In V-Block	> 10,000MΩ
Load Life	JIS-C5202 7.10 70°C at RCWV for 1,000 hrs (1.5 hr on, 0.5 hr off)	± (1.5% + 0.05Ω)
Load Life in Humidity	JIS-C5202 7.9 40 ± 2°C, 90 ~ 95% RH at RCWV for 1,000 hrs (1.5 hr on, 0.5 hr off)	± (1.5% + 0.05Ω)
Solderability	JIS-C5202 6.5 235 ± 5°C for 2 ± 0.5 seconds	95% minimum coverage
Resistance to Solvent	JIS-C5202 6.9 Trichroethane for 1 min. with ultrasonic	No deterioration of coatings and markings
Terminal Strength	Direct load for 10 seconds In the Direction of the terminal leads	Tensile ≥ 2.5kg

Rated Continuous Working Voltage (RCWV) =  $\sqrt{\text{Power Rating} \times \text{Resistance Value}}$

### PART NUMBER

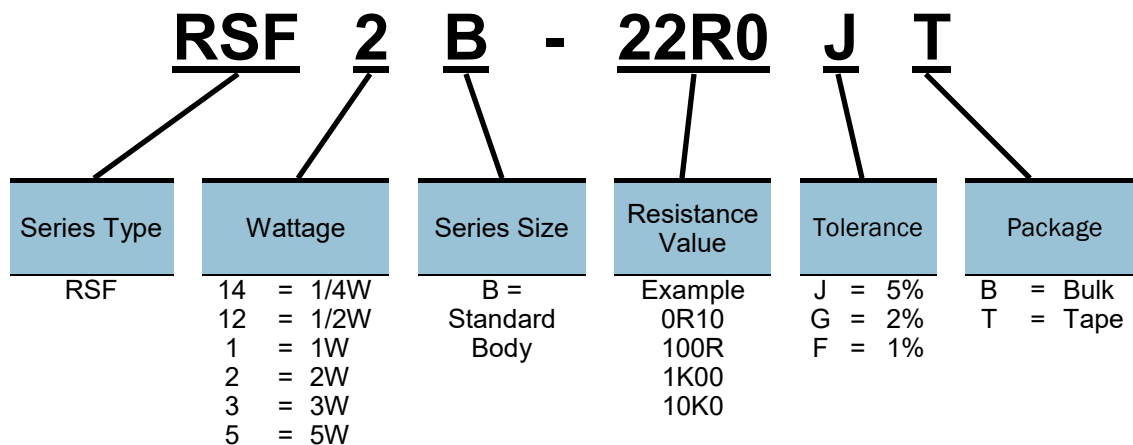

### STANDARD PACKAGING

BULK	1/4W ~ 5W	200 pieces	TAPE	1/4W	5,000 pieces
				1/2W	3,000 pieces
				1W	2,000 pieces
				2W, 3W	1,000 pieces
				5W	500 pieces

Storage Temperature: 25°C ± 3°C; Humidity < 80% RH

RSFxB Series parts are  
RoHS & REACH Compliant

# RSFxS Mini-Metal Oxide Resistor

- HIGH POWER-TO-SIZE RATIO FOR SIGNIFICANT SPACE SAVINGS
- COMPLETE FLAMEPROOF CONSTRUCTION UL-1412
- HIGH SURGE / OVERLOAD CAPABILITY
- WIDE RESISTANCE RANGE:  $0.1\Omega \sim 1M\Omega$
- RESISTANCE STANDARD TOLERANCE:  $\pm 5\%$  ( $\pm 2\%$ ,  $\pm 1\%$  AVAILABLE)
- NON-INDUCTIVE DESIGN, RESISTANCE RANGE:  $0.1\Omega \sim 100\Omega$

## POWER RATING

Miniature Type:  $1/2W \sim 7W$

## DIMENSIONS

Body Colour: Pink, Flameproof Coating

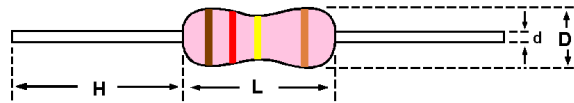

STYLE	DIMENSIONS (mm)			
	L	D	H	d
RSF12S	$6.3 \pm 0.5$	$2.3 \pm 0.3$	$28 \pm 2.0$	$0.55 \pm 0.03$
RSF1S	$9.0 \pm 0.5$	$3.2 \pm 0.5$	$26 \pm 2.0$	$0.65 \pm 0.03$
RSF2S	$11.5 \pm 1.0$	$4.5 \pm 0.5$	$35 \pm 2.0$	$0.78 \pm 0.03$
RSF3S	$15.5 \pm 1.0$	$5.0 \pm 0.5$	$32 \pm 2.0$	$0.78 \pm 0.03$
RSF5S	$17.5 \pm 1.0$	$6.5 \pm 0.5$	$35 \pm 2.0$	$0.78 \pm 0.03$
RSF7S	$24.5 \pm 1.0$	$8.5 \pm 0.5$	$35 \pm 2.0$	$0.78 \pm 0.03$

## ELECTRICAL CHARACTERISTICS

Power Rating at 70°C	0.5 W	1 W	2 W	3 W	5 W	7 W
STYLE	RSF12S	RSF1S	RSF2S	RSF3S	RSF5S	RSF7S
Operating Temperature Range	$-55^\circ\text{C} \sim +155^\circ\text{C}$					
Maximum Working Voltage	250V	300V	500V	750V	1000V	1000V
Maximum Overload Voltage	400V	500V	600V	800V	1000V	1000V
Dielectric Withstanding Volt.	350V	400V	500V	600V	750V	750V
Temperature Coefficient	$0.1\Omega \sim 10\Omega \pm 200\text{ppm}/^\circ\text{C}$ ; $1\Omega \sim 510K\Omega \pm 200\text{ppm}/^\circ\text{C}$ ; $56K\Omega \sim 1M\Omega \pm 100\text{ppm}/^\circ\text{C}$					
Range $\pm 1\% \pm 2\% \pm 5\%*$	$1\Omega \sim 510K\Omega$					

\*Resistance range for standard resistance – below or over this resistance on request.

## POWER DERATING CURVE

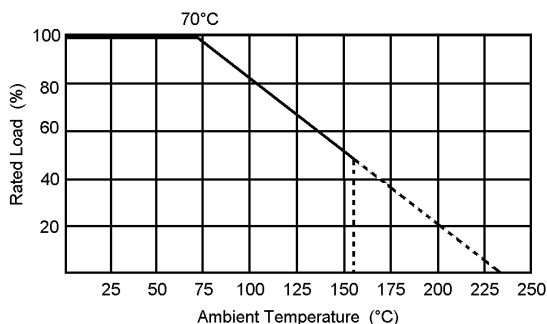

## HOT-SPOT TEMPERATURE

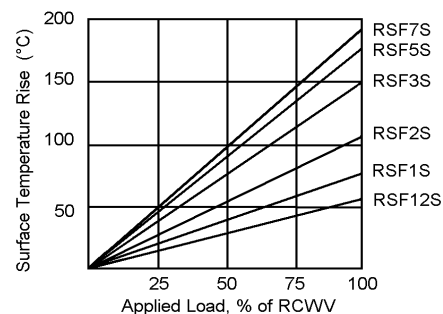

### PERFORMANCE CHARACTERISTICS

PERFORMANCE TEST	TEST METHOD	APPRAISE
Short Time Overload	JIS-C5202 5.5 2.5 times RCWV for 5 seconds	± (0.25% + 0.05Ω)
Temperature Coefficient (TCR)	Resistance value at room temperature (+100°C)	By Type
Dielectric Withstanding Voltage	JIS-C5202 5.7 In V-Block for 60 seconds	By Type
Pulse Overload	JIS-C5202 5.8 4 x RCWV for 10,000 cycles (1 seconds on, 25 seconds off)	± (1% + 0.05Ω)
Insulation Resistance	JIS-C5202 5.6 In V-Block	> 10,000MΩ
Load Life	JIS-C5202 7.10 70°C at RCWV for 1,000 hrs (1.5 hr on, 0.5 hr off)	± (1.5% + 0.05Ω)
Load Life in Humidity	JIS-C5202 7.9 40 ± 2°C, 90 ~ 95% RH at RCWV for 1,000 hrs (1.5 hr on, 0.5 hr off)	± (1.5% + 0.05Ω)
Solderability	JIS-C5202 6.5 235 ± 5°C for 2 ± 0.5seconds	95% minimum coverage
Resistance to Solvent	JIS-C5202 6.9 Trichroethane for 1 min. with ultrasonic	No deterioration of coatings and markings
Terminal Strength	Direct load for 10 seconds In the Direction of the terminal leads	Tensile ≥ 2.5kg

Rated Continuous Working Voltage (RCWV) =  $\sqrt{\text{Power Rating} \times \text{Resistance Value}}$

### PART NUMBER

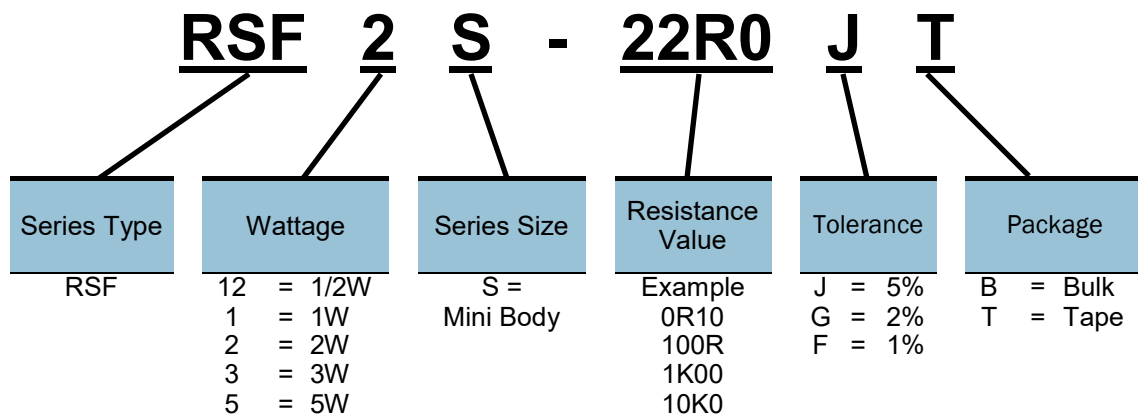

### STANDARD PACKAGING

BULK	1/2W ~ 5W	200 pieces	TAPE	1/2W	2,500 pieces
				1W	3,000 pieces
				2W	2,000 pieces
				3W	1,000 pieces

Storage Temperature: 25°C ± 3°C; Humidity < 80% RH

RSFxS Series parts are  
RoHS & REACH Compliant

# FM020x Mini-Metal Film Resistor

- FM0204 & FM0207 PROFESSIONAL SERIES RESISTOR
- VACUUM SPUTTERING DEPOSIT METAL FILM ON HIGH THERMAL CONDUCTIVITY AND SPECIFIC GRAVITY ON [HOCHEST] CERAMIC RODS
- COATED WITH MULTILAYERS OF FLAMEPROOF LACQUER
- COMPLETE FLAMEPROOF CONSTRUCTION UL-1412 (FM0207) HIGHLY RELIABLE MULTILAYER ELECTRODE

## DIMENSIONS

Body Colour:    Blue    FM0204  
                       Green    FM0207

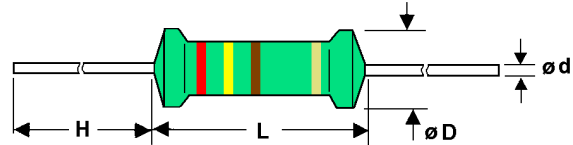

STYLE	DIMENSIONS (mm)			
	L	D	H	d
FM0204	$3.3 \pm 0.7$	$1.8 \pm 0.3$	$29 \pm 2.0$	$0.45 \pm 0.03$
FM0207	$6.3 \pm 0.5$	$2.3 \pm 0.3$	$28 \pm 2.0$	$0.55 \pm 0.03$

## ELECTRICAL CHARACTERISTICS

Power Rating at 70°C	0.4W	0.6W
STYLE	FM0204	FM0207**
DIN	44061, 45921 part 107	
CECC	40101-039, 40101-017	
MIL	10509F (Chart D&C)	
Maximum Working Voltage	200V rms	300V rms
Dielectric Withstanding Voltage	300V rms	500V rms
Temperature Coefficient	$\pm 50$ ppm	
Flameproof	(Available on Special Order)	UL-1412
Resistance Tolerance	1 %	
Value Range - IEC E24 & E96*	$51.1\Omega \sim 511K\Omega$	$10\Omega \sim 1M\Omega$

\*Resistance range for standard resistance - below or over this resistance on request

\*\*To order the FM0207 in a standard Blue (non-flameproof) finish, specify an MF0207.

## POWER DERATING CURVE

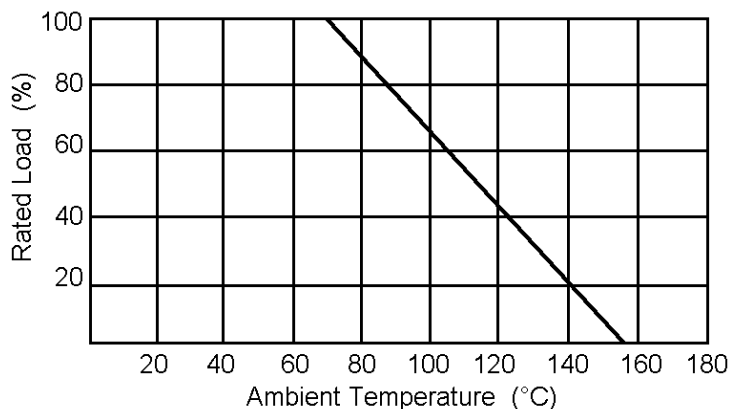

## HOT-SPOT TEMPERATURE

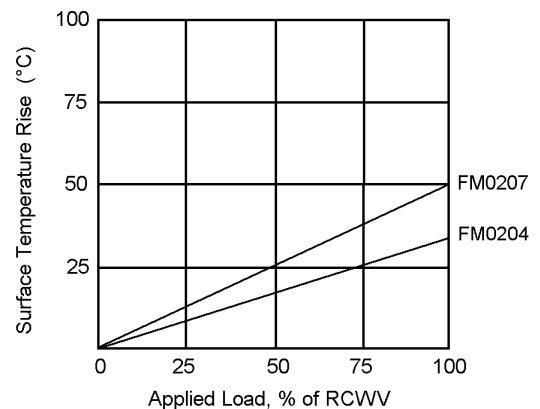

## PERFORMANCE CHARACTERISTICS

DESCRIPTION	TEST METHOD	APPRAISE
Life Stability	JIS-C-5202 7.10 70°C at RCWV for 1000 hrs (1.5 hrs on, 0.5 hrs off)	± (1.5% + 0.05Ω)
Load Life in Humidity	JIS-C-5202 7.9 40 ± 2°C, 90 - 95% RH at RCWV for 1000 hrs. (1.5 hrs on, 0.5 hrs off)	± (1.5% + 0.05Ω)
Dielectric Withstanding Voltage	JIS-C-5202 5.7 In V-Block for 60 seconds	300V rms FM0204 500V rms FM0207
Temperature Coefficient	-55°C ~ +155°C	± 50ppm/°C
Insulation Resistance	JIS-C-5202 5.6 In V-Block	> 1000MΩ
Short Time Overload	JIS-C-5202 5.5 2.5 times RCWV for 5 seconds	± (0.25% + 0.05Ω)
Pulse Overload	JIS-C-5202 5.8 4 times RCWV 1000 cycles (1 seconds on, 25 seconds off)	± (2% + 0.05Ω)
Resistance to Soldering Heat	JIS-C-5202 6.4 350°C ± 10°C for 3 ± 0.5 seconds	± (0.25% + 0.05Ω)
Temperature Cycling (Climatic Sequence)	JIS-C-5202 7.4 -65°C → room temp → 150°C → room temp. for 5 cycles	± (0.25% + 0.05Ω)
Resistance to Solvents and Colour Coding	JIS-C-5202 6.9 Trichroethane for 1 minute with Ultrasonic	No deterioration of Coatings and Markings
Solderability	JIS-C-5202 6.5 235°C solder for 5 ± 0.5 seconds	> 95% coverage
Terminal Strength	Direct load for 10 seconds in the direction of the terminal leads	≥ 2.5kg (24.5N)
Low Temperature Operation	-65°C	± 0.25%
Failure Rate		< 10 <sup>-8</sup> /H

Rated Continuous Working Voltage (RCWV) =  $\sqrt{\text{Power Rating} \times \text{Resistance Value}}$

## PART NUMBER

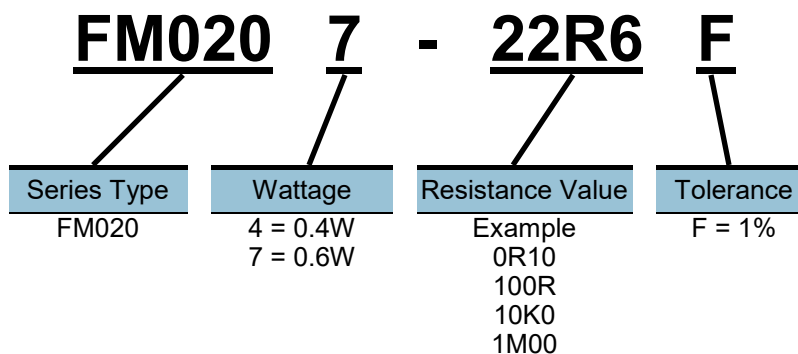

## STANDARD PACKAGING

TAPE 0.4W, 0.6W 5,000 pieces

Storage Temperature: 25°C ± 3°C; Humidity < 80% RH

FM020x Series parts are  
RoHS & REACH Compliant

# MF020x Mini-Metal Film Resistor

- MF0204 & MF0207 PROFESSIONAL SERIES RESISTOR
- VACUUM SPUTTERING DEPOSIT METAL FILM ON HIGH THERMAL CONDUCTIVITY AND SPECIFIC GRAVITY ON [HOCHST] CERAMIC RODS
- COATED WITH MULTILAYERS OF BLUE LACQUER

## DIMENSIONS

Body Colour: Blue

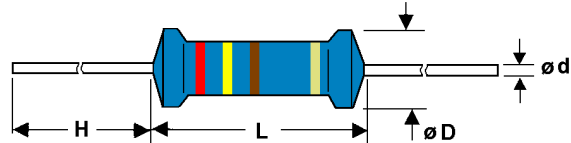

STYLE	DIMENSIONS (mm)			
	L	D	H	d
MF0204	$3.3 \pm 0.7$	$1.8 \pm 0.3$	$29 \pm 2.0$	$0.45 \pm 0.03$
MF0207	$6.3 \pm 0.5$	$2.3 \pm 0.3$	$28 \pm 2.0$	$0.55 \pm 0.03$

## ELECTRICAL CHARACTERISTICS

Power Rating at 70°C	0.4W	0.6W
STYLE	MF0204	MF0207**
DIN	44061, 45921 part 107	
CECC	40101-039, 40101-017	
MIL	10509F (Chart D&C)	
Maximum Working Voltage	200V rms	300V rms
Dielectric Withstanding Voltage	300V rms	500V rms
Temperature Coefficient	$\pm 50$ ppm	
Resistance Tolerance	1 %	
Value Range - IEC E24 & E96*	51.1Ω ~ 511KΩ	10Ω ~ 1MΩ

\*Resistance range for standard resistance - below or over this resistance on request

\*\*To order the MF0207 in a Flameproof finish, specify an FM0207.

## POWER DERATING CURVE

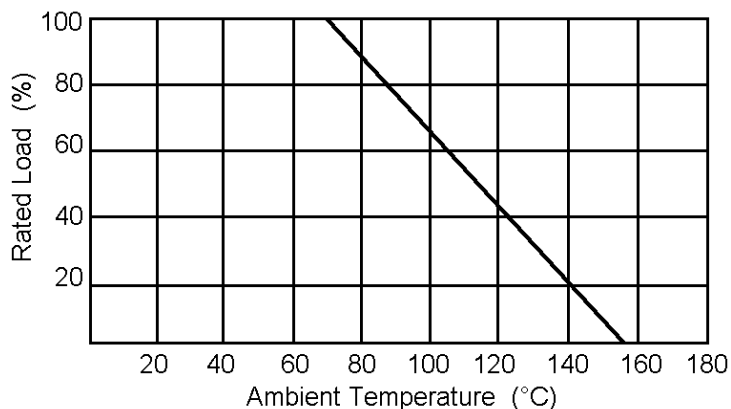

## HOT-SPOT TEMPERATURE

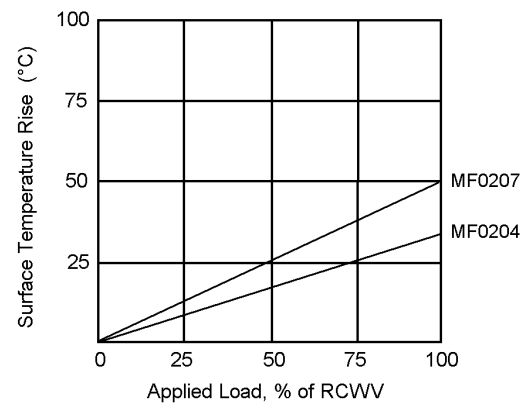

**PERFORMANCE CHARACTERISTICS**

DESCRIPTION	TEST METHOD	APPRAISE
Life Stability	JIS-C-5202 7.10 70°C at RCWV for 1000 hrs (1.5 hrs on, 0.5 hrs off)	± (1.5% + 0.05Ω)
Load Life in Humidity	JIS-C-5202 7.9 40 ± 2°C, 90 - 95% RH at RCWV for 1000 hrs. (1.5 hrs on, 0.5 hrs off)	± (1.5% + 0.05Ω)
Dielectric Withstanding Voltage	JIS-C-5202 5.7 In V-Block for 60 seconds	300V rms MF0204 500V rms MF0207
Temperature Coefficient	-55°C ~ +155°C	± 50ppm/°C
Insulation Resistance	JIS-C-5202 5.6 In V-Block	> 1000MΩ
Short Time Overload	JIS-C-5202 5.5 2.5 times RCWV for 5 seconds	± (0.25% + 0.05Ω)
Pulse Overload	JIS-C-5202 5.8 4 times RCWV 1000 cycles (1 second on, 25 seconds off)	± (2% + 0.05Ω)
Resistance to Soldering Heat	JIS-C-5202 6.4 350°C ± 10°C for 3 ± 0.5 seconds	± (0.25% + 0.05Ω)
Temperature Cycling (Climatic Sequence)	JIS-C-5202 7.4 -65°C → room temp → 150°C → room temp. for 5 cycles	± (0.25% + 0.05Ω)
Resistance to Solvents and Colour Coding	JIS-C-5202 6.9 Trichroethane for 1 minute with ultrasonic	No deterioration of Coatings and Markings
Solderability	JIS-C-5202 6.5 235°C solder for 5 ± 0.5 seconds	> 95% coverage
Terminal Strength	Direct load for 10 seconds in the direction of the terminal leads	≥ 2.5kg (24.5N)
Low Temperature Operation	-65°C	± 0.25%
Failure Rate		< 10 <sup>-8</sup> /H

Rated continuous Working Voltage (RCWV) =  $\sqrt{\text{Power Rating} \times \text{Resistance Value}}$

**PART NUMBER**

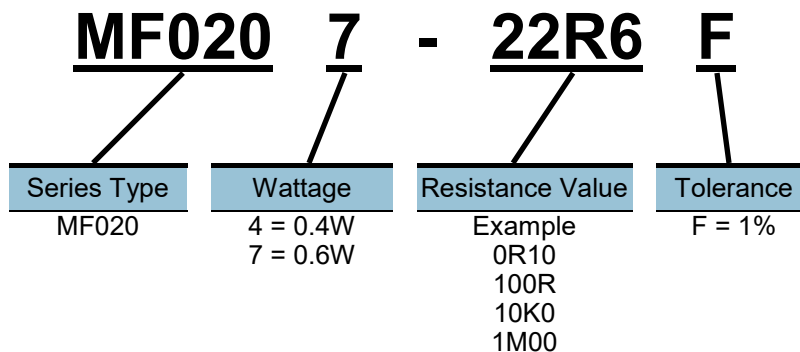

**STANDARD PACKAGING**

TAPE 0.4W, 0.6W 5,000 pieces

Storage Temperature: 25°C ± 3°C; Humidity < 80% RH

FM020x Series parts are  
RoHS & REACH Compliant



# MO Super Mini-Metal Oxide Resistor

- EXCELLENT LONG-TERM STABILITY
- SMALLER BODY SIZE THAN RSF<sub>x</sub>S SERIES
- MEETS MIL-R-22684B
- FLAME RETARDANT
- NON-INDUCTIVE VERSION AVAILABLE

## DIMENSIONS

Body Colour: Grey

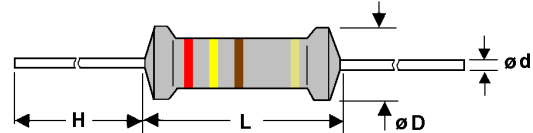

STYLE	DIMENSIONS (mm)			
	L	D	H	d
MO-100SS	6 ± 0.5	2.3 ± 0.3	25 ± 3.0	0.56 ± 0.1
MO-200SS	9 ± 0.5	3.2 ± 0.5	25 ± 3.0	0.6 ± 0.1
MO-300SS	11 ± 1.0	4.5 ± 0.5	35 ± 3.0	0.8 ± 0.1

## ELECTRICAL CHARACTERISTICS

Power Rating at 70°C	1W	2W	3W
STYLE	MO-100SS	MO-200SS	MO-300SS
MIL	MIL-R-22684B		
Maximum Working Voltage	200V rms	350V rms	500V rms
Maximum Overload Voltage	400V rms	700V rms	800V rms
Dielectric Withstanding Voltage	300V rms	500V rms	700V rms
Temperature Coefficient	± 300 ppm		
Operating Temperature Range	-55°C ~ +155°C		
Resistance Tolerance	5%, 2%, 1%		
Value Range - IEC E24 & E96	0.1Ω ~ 1KΩ		

## POWER DERATING CURVE

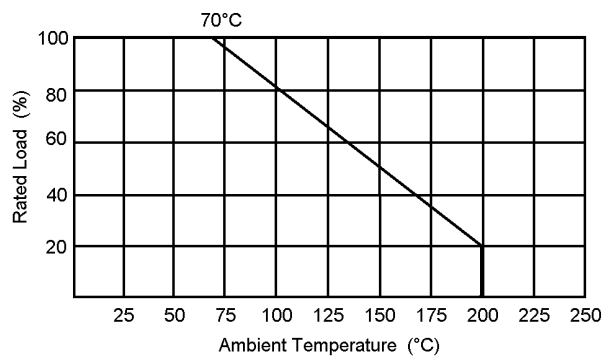

**PERFORMANCE CHARACTERISTICS**

DESCRIPTION	TEST METHOD	APPRAISE
Load Life	JIS-C-5202 7.10 70°C at RCWV for 1000 hrs (1.5 hrs on, 0.5 hrs off)	± (5% + 0.05Ω)
Load Life in Humidity	JIS-C-5202 7.9 40 ± 2°C, 90 - 95% RH at RCWV for 1000 hrs. (1.5 hrs on, 0.5 hrs off)	± (5% + 0.05Ω)
Dielectric Withstanding Voltage	JIS-C-5202 5.7 In V-Block for 60 seconds	300V rms MO-100SS 500V rms MO-200SS
Temperature Coefficient	-55°C ~ +155°C	± 300ppm/°C
Insulation Resistance	JIS-C-5202 5.6 In V-Block	> 1000MΩ
Short Time Overload	JIS-C-5202 5.5 2.5 times RCWV for 5 seconds	± (1% + 0.05Ω)
Pulse Overload	JIS-C-5202 5.8 4 times RCWV 1000 cycles (1 second on, 25 second off)	± (5% + 0.05Ω)
Resistance to Soldering Heat	JIS-C-5202 6.4 350°C ± 10°C for 3 ± 0.5 seconds	± (1% + 0.05Ω)
Temperature Cycling (Climatic Sequence)	JIS-C-5202 7.4 -65°C → room temp → 150°C → room temp. for 5 cycles	± (1% + 0.05Ω)
Resistance to Solvents and Colour Coding	JIS-C-5202 6.9 Trichroethane for 1 minute with Ultrasonic	No deterioration of coatings and markings
Solderability	JIS-C-5202 6.5 235°C solder for 5 ± 0.5 seconds	95% minimum coverage
Terminal Strength	Direct load for 10 seconds in the direction of the terminal leads	≥ 2.5kg (24.5N)

Rated Continuous Working Voltage (RCWV) =  $\sqrt{\text{Power Rating} \times \text{Resistance Value}}$

**PART NUMBER**

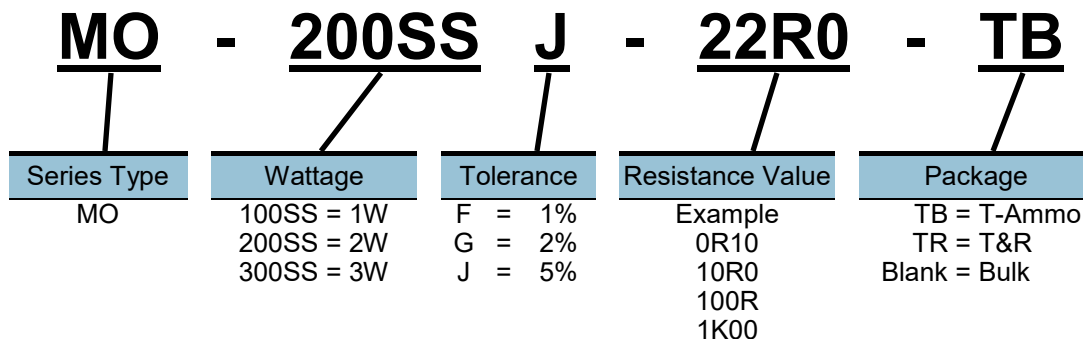

**STANDARD PACKAGING\***

BULK	1W ~ 3W	1,000 pieces	T&R	1W	5,000 pieces
				2W, 3W	2,500 pieces
			T-AMMO	1W	5,000 pieces
				2W	2,000 pieces
				3W	1,000 pieces

\*MOQ - 20,000 pieces per value  
Factory preferred packaging is T-Ammo.

MO Series parts are  
RoHS & REACH Compliant

# MG Metal Glazed Resistor

- COAT-INSULATED MEGOHM FIXED RESISTOR
- HIGHER WORKING VOLTAGE
- HIGH PULSE LOADING CAPABILITY
- RESISTANCE TO HIGH TEMP/HUMIDITY
- AVAILABLE IN 5% AND 1% TOLERANCE

## DIMENSIONS

MGS = Silicone Resin - Brown Body (Flameproof)  
MGE = Epoxy Resin - Light Blue

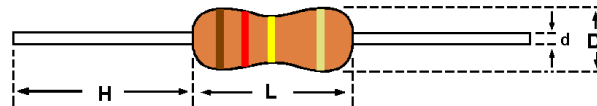

STYLE	DIMENSIONS (mm)			
	L	D	H	d
MG14 / MG12S	6.3 ± 0.5	2.3 ± 0.3	28 ± 2.0	0.55 ± 0.03
MG12 / MG1S	9.0 ± 0.5	3.2 ± 0.5	26 ± 2.0	0.65 ± 0.03
MG1 / MG2S	11.5 ± 1.0	4.5 ± 0.5	35 ± 2.0	0.78 ± 0.03
MG2	15.5 ± 1.0	5.0 ± 0.5	32 ± 2.0	0.78 ± 0.03
MG3S	15.5 ± 1.0	5.0 ± 0.5	32 ± 2.0	0.78 ± 0.03

## ELECTRICAL CHARACTERISTICS

Power Rating at 70°C	1/4 W	1/2 W	1/2 WS	1 W	1 WS	2W	2 WS	3W
STYLE	MG14	MG12	MG12S	MG1	MG1S	MG2	MG2S	MG3S
Maximum Working Voltage DC	1600V	3500V	1700V	4500V	4000V	7000V	5000V	7000V
Dielectric Withstanding - Voltage	Silicone	400V	500V	400V	500V	500V	700V	500V
	Epoxy	500V	700V	500V	1000V	700V	1200V	1000V
Maximum Overload Voltage DC	2000V	4000V	2500V	5000V	4500V	14000V	10000V	14000V
Temperature Coefficient	1K $\Omega$ - $\leq$ 1 G $\Omega$ $\pm$ 200ppm/ $^{\circ}$ C, > 1G $\Omega$ $\pm$ 200ppm/ $^{\circ}$ C, (Special $\pm$ 100ppm/ $^{\circ}$ C)							
Rating Ambient Temperature	70 $^{\circ}$ C							
Operating Temperature	-55 $^{\circ}$ C ~ +175 $^{\circ}$ C							
Resistance Tolerance	1%, 5%, 10% (> 1G $\Omega$ 10%)							
Value Range - IEC E24*	1K $\Omega$ ~ 10G $\Omega$							

## POWER DERATING CURVE

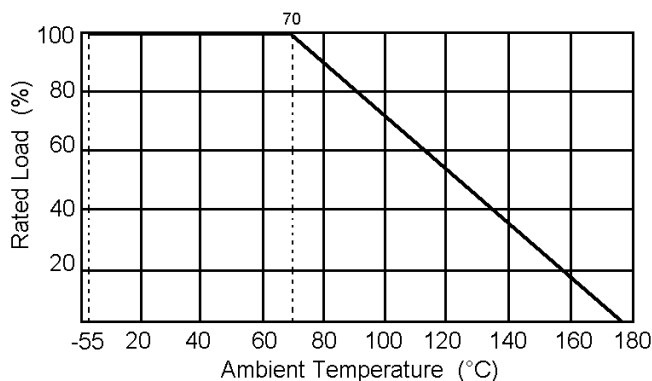

## HOT-SPOT TEMPERATURE

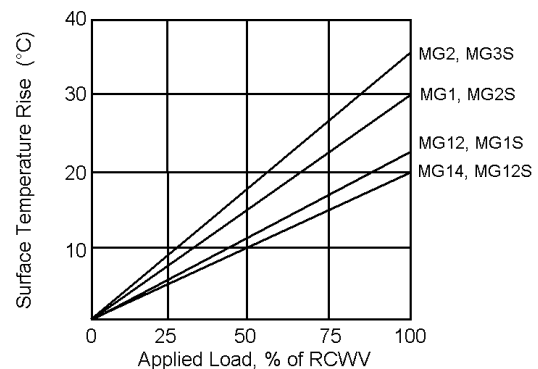

**PERFORMANCE CHARACTERISTICS**

DESCRIPTION	TEST METHOD	SPECIFICATIONS
Load Life	1,000 hours at rated voltage, 70°C 90 min on, 30 min off	± (3.0% + 0.05Ω)
Moisture Resistance	40°C ± 2°C, 90%~95% RH, 1,000 hr 90 min on, 30 min off	± (5.0% + 0.05Ω)
Dielectric Withstanding Voltage	In V-Block for 60 seconds	By type
Insulation Resistance	500 ± 50V DC During 1 minute V-Block method	± 10,000 MΩ Over
Short Time Overload	Rated Voltage x 2.5 or Max overload V, which ever is lower	± (1.0% + 0.05Ω)
Low Temperature Operation		± (1.0% + 0.05Ω)
Resistance to Soldering Heat Temperature Cycling	260°C ± 5°C, 10 seconds ± 1 sec 350°C ± 10°C, 3.5 seconds ± 0.5 sec	± (1.0% + 0.05Ω)
Intermittent Overload	4 times RCWV for 10,000 cycles (1 seconds on, 25 seconds off)	± (1.0% + 0.05Ω)
Terminal Strength	Direct load for 10 seconds in direction of the terminal leads	Tensile: ≥ 2.5kg

Rated Continuous Working Voltage (RCWV) =  $\sqrt{\text{Power Rating} \times \text{Resistance Value}}$

**PART NUMBER**

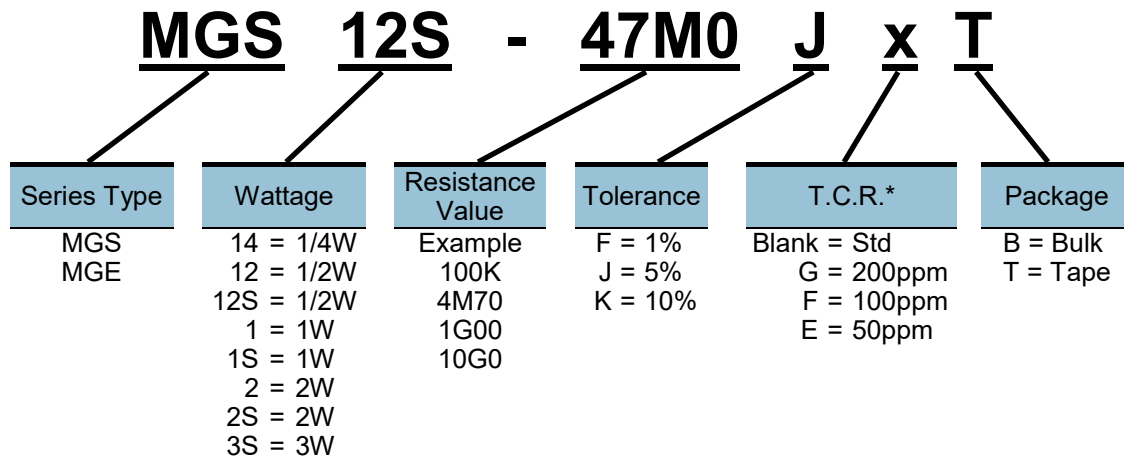

**STANDARD PACKAGING**

BULK 1/4W ~ 3WS 1,000 pieces

TAPE 1/4W, 1/2WS 5,000 pieces  
 1/2W, 1WS 2,500 pieces  
 1W, 2WS 2,000 pieces  
 2W, 3WS 1,000 pieces

NOTE - This series is a special order product.

MG Series parts are  
RoHS & REACH Compliant

# SURC Anti-Surge Resistor

- COAT-INSULATED FIXED RESISTOR
- WATTAGES FROM 1/2W TO 7W
- AVAILABLE IN 5%, 10% & 20% TOLERANCE

## DIMENSIONS

Body Colour: 1/2W~ 3WS Brown  
3W ~ 7WS Grey

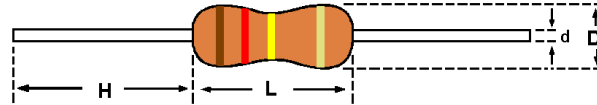

STYLE	DIMENSIONS (mm)			
	L	D	H	d
SURC12 / SURC1S	9.0 ± 0.5	3.2 ± 0.5	26 ± 2.0	0.65 ± 0.03
SURC1 / SURC2S	11.5 ± 1.0	4.5 ± 0.5	35 ± 2.0	0.78 ± 0.03
SURC2 / SURC3S	15.5 ± 1.0	5.0 ± 0.5	32 ± 2.0	0.78 ± 0.03
SURC3 / SURC5S	17.5 ± 1.0	6.5 ± 0.5	35 ± 2.0	0.78 ± 0.03
SURC5 / SURC7S	24.5 ± 1.0	8.0 ± 0.5	35 ± 2.0	0.78 ± 0.03

## ELECTRICAL CHARACTERISTICS

Power Rating at 70°C	1/2 W / 1WS	1W / 2WS	2W / 3WS	3W / 5WS	5W / 7WS
STYLE	SURC12 SURC1S	SURC1 SURC2S	SURC2 SURC3S	SURC3 SURC5S	SURC5 SURC7S
Maximum Working Voltage DC	200V	200V	300V	400V	500V
Dielectric Withstanding Voltage	500V	500V	500V	500V	500V
Maximum Overload Voltage DC	300V	400V	600V	800V	1,000V
MAX Anti-Surge	3,000V	6.2Ω <10KV 10Ω <7KV 10KΩ <5KV	10,000V	10,000V	12,000V
Temperature Coefficient	±300ppm/°C				
Operating Temperature	-40°C ~ +200°C				
Resistance Tolerance	5%, 10% (10Ω ~ 10KΩ), 20% (3.3Ω ~ 9.9Ω)				
Value Range - IEC E24*	10Ω ~ 10KΩ				

## POWER DERATING CURVE

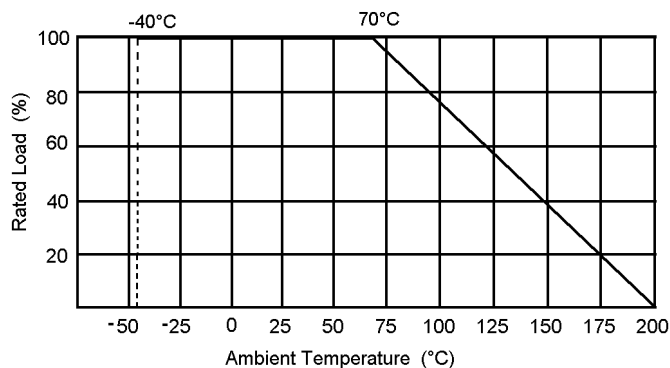

## HOT-SPOT TEMPERATURE

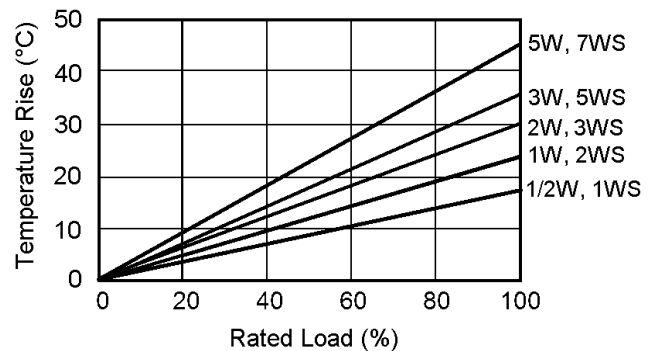

### PERFORMANCE CHARACTERISTICS

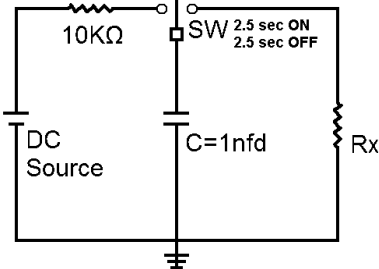
DESCRIPTION	TEST METHOD	SPECIFICATIONS
Short Time Overload	Rated voltage xv2.5 or maximum overload voltage, whichever is lower, for 5 seconds	± (1.0% + 0.05Ω)
Temperature Coefficient (TCR)	Resistance value at room temperature (+25°C) and room temperature (+125°C)	± 300ppm
Anti-Surge Characteristics (EN60065 Test)	Discharge Test: 1/2W, 1WS = 3KV 1W, 2WS 3Ω~6Ω = 10KV 7Ω~10Ω = 7KV 11Ω~10KΩ = 5KV 2W, 3WS = 10KV 3W, 5WS = 10KV 5W, 7WS = 12KV  10KV 1nfd capacitor Discharge plus 50 times. (1 pulse / 5seconds maximum) 	± (20% + 0.05Ω)
Moisture Resistance	40°C ± 2°C 90% ~ 95% RH 1000 hr, 90 min on 30 min off	± (5.0% + 0.05Ω)
Resistance to Soldering Heat	260°C ± 5°C, 10 sec ± 1 seconds 350°C ± 10°C, 3.5 sec ± 0.5 seconds	± (1.0% + 0.05Ω)
Load Life	1000 hr at rated voltage, 40°C, 90 min on 30 min off	± (5.0% + 0.05Ω)
Terminal Strength	Direct load for 10 sec in the direction of the terminal leads	Tensile ≥2.5kg

Rated Continuous Working Voltage (RCWV) =  $\sqrt{\text{Power Rating} \times \text{Resistance Value}}$

Resistance to anti-surge : change shall be ± 5% of the per-test values. 1 second on, 1 second off for 20,000 cycles.

### PART NUMBER

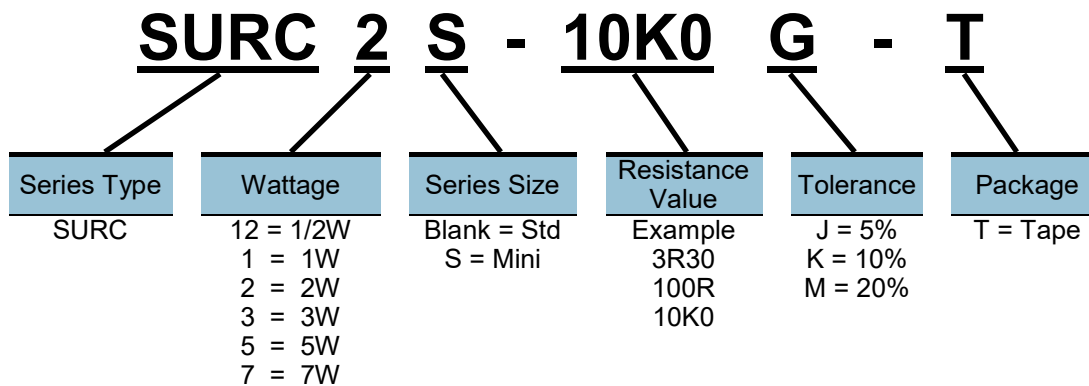

### STANDARD PACKAGING

TAPE & REEL	1/2W, 1WS	3,000 pieces
	1W, 2WS	2,000 pieces
	2W, 3WS	1,000 pieces
	3W, 5WS	1,000 pieces
	5W, 7WS	500 pieces

SURC Series parts are RoHS & REACH Compliant

# SURM Anti-Surge Resistor

- COAT-INSULATED FIXED RESISTOR
- HIGHER WORKING VOLTAGE THAN SURC SERIES
- AVAILABLE IN 1%, 2%, 5% & 10% TOLERANCE

## DIMENSIONS

Body Colour: Brown

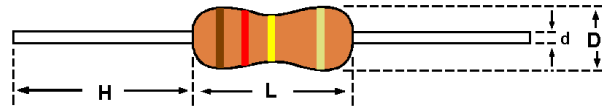

STYLE	DIMENSIONS (mm)			
	L	D	H	d
SURM14 / SURM12S	$6.3 \pm 0.5$	$2.3 \pm 0.3$	$28 \pm 2.0$	$0.55 \pm 0.03$
SURM12 / SURM1S	$9.0 \pm 0.5$	$3.2 \pm 0.5$	$26 \pm 2.0$	$0.65 \pm 0.03$
SURM1 / SURM2S	$11.5 \pm 1.0$	$4.5 \pm 0.5$	$35 \pm 2.0$	$0.78 \pm 0.03$
SURM2 / SURM3S	$15.5 \pm 1.0$	$5.0 \pm 0.5$	$32 \pm 2.0$	$0.78 \pm 0.03$

## ELECTRICAL CHARACTERISTICS

Power Rating at 70°C	1/4 W / 1/2WS	1/2 W / 1WS	1W / 2WS	2W / 3WS
STYLE	SURM14 SURM12S	SURM12 SURM1S	SURM1 SURM2S	SURM2 SURM3S
Maximum Working Voltage DC	1,600V	2,000V	4,000V	5,000V
Dielectric Withstanding Voltage	500V	500V	500V	700V
Maximum Overload Voltage DC	2,000V	4,000V	2,500V	5,000V
MAX Anti-Surge	5,000V	10,000V	15,000V	25,000V
Temperature Coefficient	$\pm 200 \text{ ppm}/^\circ\text{C}$			
Operating Temperature	$-40^\circ\text{C} \sim +200^\circ\text{C}$			
Resistance Tolerance	1%, 2%, 5% (1K $\Omega$ ~ 1M $\Omega$ ), 10% (1K $\Omega$ ~ 1G $\Omega$ )			
Value Range - IEC E24*	1K $\Omega$ ~ 1G $\Omega$			

## POWER DERATING CURVE

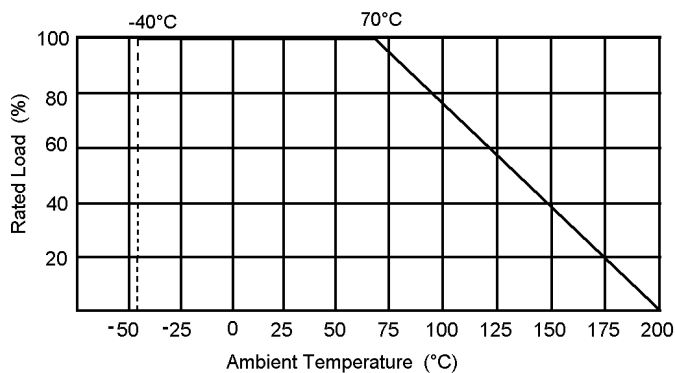

## HOT-SPOT TEMPERATURE

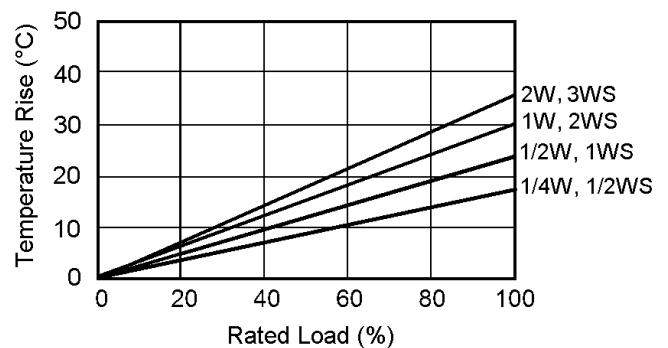

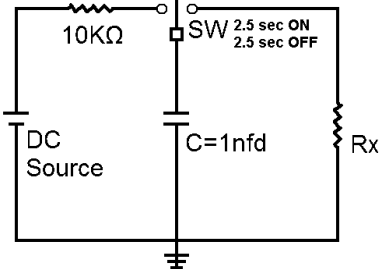

**PERFORMANCE CHARACTERISTICS**

DESCRIPTION	TEST METHOD	SPECIFICATIONS
Short Time Overload	Rated voltage x 2.5 or Maximum overload voltage, whichever is lower, for 5 seconds	± (1.0% + 0.05Ω)
Temperature Coefficient (TCR)	Resistance value at room temperature (+25°C) and room temperature (+125°C)	± 200ppm
Anti-Surge Characteristics	Discharge Test: 1/4W, 1/2WS = 5KV 1/2W, 1WS = 10KV 1W, 2WS = 15KV 2W = 25KV 3WS = 36KV 	± (5.0% + 0.05Ω)
Short Time Overload	Rated Voltage x 2.5 or Max overload V, which ever is lover	± (1.0% + 0.05Ω)
Moisture Resistance	40°C ± 2°C 90% ~ 95% RH 1000 hr, 90 min on 30 min off	± (5.0% + 0.05Ω)
Resistance to Soldering Heat	260°C ± 5°C, 10 sec ± 1 seconds 350°C ± 10°C, 3.5 sec ± 0.5 seconds	± (1.0% + 0.05Ω)
Load Life	1000 hr at rated voltage, 70°C, 90 min on 30 min off	± (5.0% + 0.05Ω)
Resistance to Solvent	IPA for 5± 0.5 Min with ultrasonic	No abnormality in coatings and markings

Rated Continuous Working Voltage (RCWV) =  $\sqrt{\text{Power Rating} \times \text{Resistance Value}}$

Resistance to anti-surge : change shall be ± 5% of the per-test values. 1 second on, 1 second off for 20,000 cycles.

**PART NUMBER**

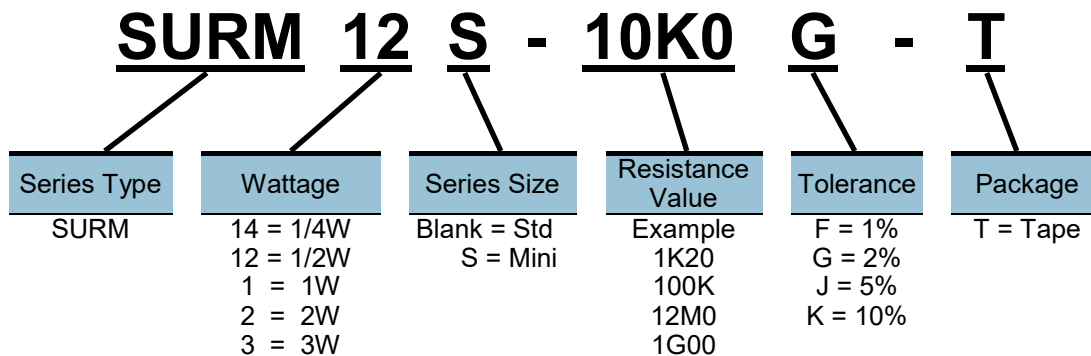

**STANDARD PACKAGING**

TAPE & REEL	1/4W, 1/2WS	2,500 pieces
	1/2W, 1WS	3,000 pieces
	1W, 2WS	2,000 pieces
	2W, 3WS	1,000 pieces

SURM Series parts are  
RoHS & REACH Compliant

# MF & FMF Metal Film Resistor

- VERY LOW CURRENT NOISE
- LOW TCR 100ppm, TO 10ppm
- WIDE TOLERANCE RANGE 1%, TO 0.01% (5% also available)
- MEETS MIL SPECIFICATION MIL-R-10509F
- FLAMEPROOF (FMF SERIES)

## POWER RATING

1/8W ~ 3W

## DIMENSIONS

Body Colour: MF - Light Blue  
FMF - Green

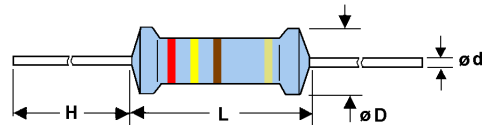

STYLE	DIMENSIONS (mm)			
	L	D	H	d
MF12	3.2 ± 0.2	1.5 ± 0.2	28 ± 2	0.48 ± 0.05
MF25S	3.2 ± 0.2	1.5 ± 0.2	28 ± 2	0.48 ± 0.05
MF25	6.0 ± 0.5	2.3 ± 0.3	28 ± 2	0.56 ± 0.05
MF40S	3.2 ± 0.2	1.5 ± 0.2	28 ± 2	0.48 ± 0.05
MF50S	6.0 ± 0.5	2.3 ± 0.3	28 ± 2	0.56 ± 0.05
MF50	9.0 ± 0.5	3.2 ± 0.5	28 ± 2	0.60 ± 0.05
MF60S	6.0 ± 0.5	2.3 ± 0.3	28 ± 2	0.56 ± 0.05
MF100 / MF200S	11 ± 1.0	4.5 ± 0.5	35 ± 3	0.80 ± 0.05
MF200	15 ± 1.0	5.0 ± 0.5	35 ± 3	0.80 ± 0.05
MF300S	15 ± 1.0	5.0 ± 0.5	35 ± 3	0.80 ± 0.05

## ELECTRICAL CHARACTERISTICS

Power Rating at 70°C	0.125W	0.25W	0.25W	0.4W	0.5W	0.5W	0.6W	1W/2W	2W	3W
STYLE	MF12	MF25S	MF25	MF40S	MF50S	MF50	MF60S	MF100 MF200S	MF200	MF300S
Operating Temp. Range	-55°C ~ +155°C									
Maximum Working Voltage	200V	250V	250V	350V	350V	350V	350V	500V	500V	500V
Maximum Overload Voltage	400V	500V	500V	700V	700V	700V	700V	1000V	1000V	1000V
Dielectric Withstanding Volt.	300V	400V	500V	500V	500V	500V	500V	1000V	1000V	1000V
Temperature Coefficient	± 100ppm/°C Standard (Available ± 10ppm/°C, ± 15ppm/°C, ± 25 ppm/°C, ± 50ppm/°C)									
Value Range ±0.5% ±1%*	10Ω ~ 1MΩ *									
Value Range ±0.25% ±0.1%	100Ω ~ 100KΩ									

\*Resistance range 0.1Ω ~ <10Ω and >1MΩ ~ 30MΩ available on SPECIAL ORDER

### Derating Curve

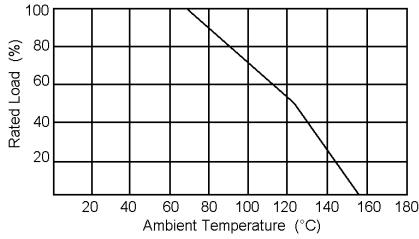

### Load Life

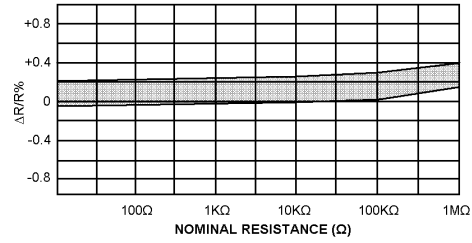

### Current Noise

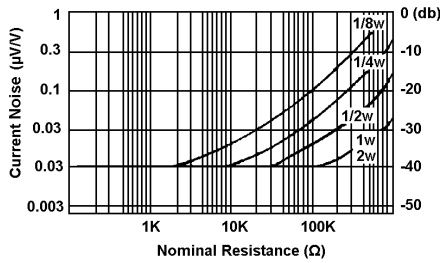

### High Frequency

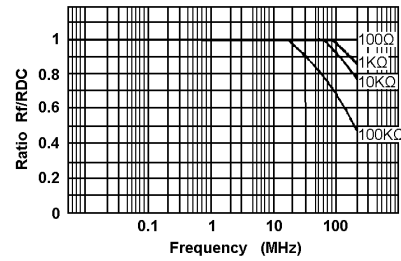

### Surface Temp. Rise vs. Load

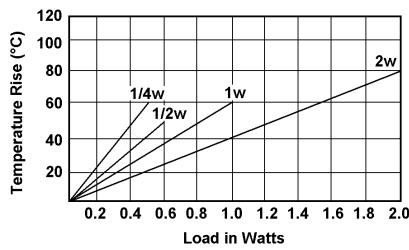

Re-

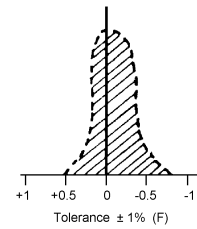

### PART NUMBER

**MF 60S - 22R6 F D T**

Series Type	Wattage	Resistance Value	Tolerance	T.C.R.*	Package
MF	12 = 1/8W	Example	J = 5%	F = 100ppm*	T = Tape
FMF	25 = 1/4W	0R10	F = 1%	E = 50ppm	
	40S = 0.4W	100R	D = 0.5%	D = 25ppm	
	50 = 1/2W	10K0	C = 0.25%	C = 15ppm	
	60S = 0.6W	1M00	B = 0.1%		
	100 = 1W				
	200 = 2W				
	300 = 3W				

\*Note that unless otherwise stipulated, the standard supplied TCR is 100ppm. The "F" TCR code is not used when ordering the standard part. Example: MF40S-499RFT = 0.4W, 499Ω, 1%, 100ppm, Tape. The TCR code is used only when a TCR other than the standard is required. For 5% tolerance parts, do not include TCR designation in part number.

### STANDARD PACKAGING

BULK Not Available TAPE 1/8W, 1/4W, 0.4W, 0.6W 5000  
1/2W ~ 3W Call

NOTE - This series is a special order product.

MF/MFM Series parts are  
RoHS & REACH Compliant

# RNF Fusible Metal Film Resistor

- SUPERIOR QUALITY FUSIBLE RESISTORS WHICH ARE FLAMEPROOF DURING OPERATION
- RESISTORS FUSE IN LESS THAN 30 SECONDS AT 16 TIMES RATED POWER
- RESISTORS ARE MARKED WITH 4 COLOUR BAND CODE INDICATING THE VALUE AND A 5TH BLACK BAND DENOTING A FUSIBLE RESISTOR

## POWER RATING

1/4W ~ 2W

## DIMENSIONS

Colour: Grey

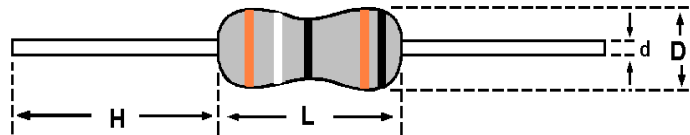

STYLE	DIMENSIONS (mm)			
	L	D	H	d
RNF14	6.3 ± 0.5	2.3 ± 0.5	28 ± 2.0	0.55 ± 0.03
RNF12	9.0 ± 0.5	3.2 ± 0.5	26 ± 2.0	0.65 ± 0.03
RNF1	11.5 ± 1.0	4.5 ± 0.5	35 ± 2.0	0.78 ± 0.03
RNF2	15.5 ± 1.0	5.0 ± 0.5	32 ± 23.0	0.78 ± 0.03

## ELECTRICAL CHARACTERISTICS

Power Rating at 70°C	1/4W	1/2W	1W	2W
STYLE	RNF14	RNF12	RNF1	RNF2
Limiting Element Voltage	200V	250V	300V	350V
Temperature Coefficient	± 350ppm/°C			
Short Time Overload	± (2% + 0.05Ω)			
Operating Temperature	-40°C ~ +155°C			
Resistance Tolerance	2% ~ 5%			
Value Range - IEC E24*	4Ω7 ~ 1KΩ	1Ω ~ 1KΩ		

\*Resistance range for standard resistance – below or over this resistance on request.

## POWER DERATING CURVE

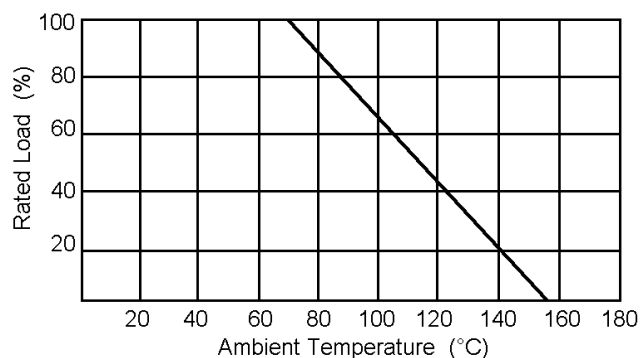

See Page 28 for additional specifications and part number information

# RNFM Mini Fusible Metal Film Resistor

- SUPERIOR QUALITY FUSIBLE RESISTORS WHICH ARE FLAMEPROOF DURING OPERATION
- RESISTORS FUSE IN LESS THAN 30 SECONDS AT 16 TIMES RATED POWER
- RESISTORS ARE MARKED WITH 4 COLOUR BAND CODE INDICATING THE VALUE AND A 5TH BLACK BAND DENOTING A FUSIBLE RESISTOR

## POWER RATING

1/2W ~ 3W

## DIMENSIONS

Colour: Pink

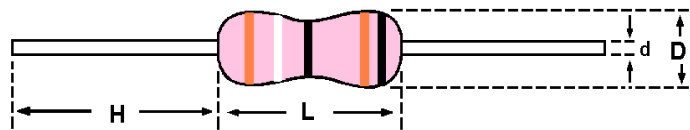

STYLE	DIMENSIONS (mm)			
	L	D	H	d
RNF12	6.3 ± 0.5	2.3 ± 0.5	28 ± 2.0	0.55 ± 0.03
RNF1	9.0 ± 0.5	3.2 ± 0.5	26 ± 2.0	0.65 ± 0.03
RNF2	11.5 ± 1.0	4.5 ± 0.5	35 ± 2.0	0.78 ± 0.03
RNF3	15.5 ± 1.0	5.0 ± 0.5	32 ± 23.0	0.78 ± 0.03

## ELECTRICAL CHARACTERISTICS

Power Rating at 70°C	1/2W	1W	2W	3W
STYLE	RNFM12	RNFM1	RNFM2	RNFM3
Limiting Element Voltage	250V	300V	350V	400V
Temperature Coefficient	± 350ppm/°C			
Short Time Overload	± (2% + 0.05Ω)			
Operating Temperature	-40°C ~ +155°C			
Resistance Tolerance	2% ~ 5%			
Value Range - IEC E24*	4Ω7 ~ 1KΩ		1Ω ~ 1KΩ	

\*Resistance range for standard resistance – below or over this resistance on request.

## POWER DERATING CURVE

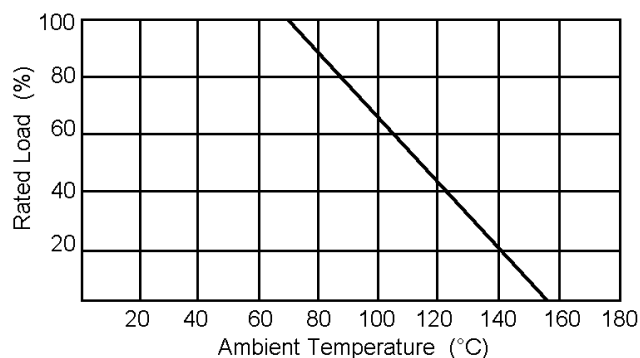

See Page 28 for additional specifications and part number information



## ENVIRONMENTAL CHARACTERISTICS

DESCRIPTION	Specification Limits
Resistance Value	Within specified tolerance
Temperature Coefficient	T.C.R. Within $\pm 350\text{ppm}/^\circ\text{C}$
Short-time Overload	Within $\pm (2\% + 0.05 \Omega)$
Insulation Resistance Min Dry	1000M $\Omega$
Dielectric Withstanding Voltage	$\geq 500\text{V}$
Terminal Strength	Tensile: $\geq 2.5\text{kg}$
Solderability	95% of the dipping surface must be covered by new solder
Load Life	Within $\pm (5\% + 0.05 \Omega)$ No major visible damage, Marking legible
Fusible Characteristics	Less than 30 seconds at 16 times rated power.

Rated Continuous Working Voltage (RCWV) =  $\sqrt{\text{Power Rating} \times \text{Resistance Value}}$

## FUSING CHARACTERISTICS

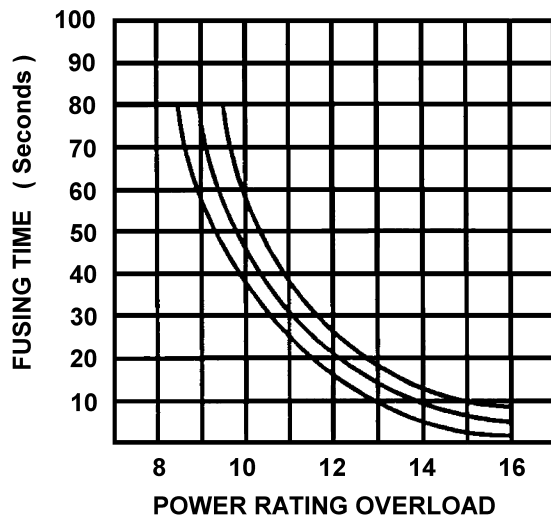

Type		Magnification of Power Rating			Fuse Time
RNF	NRNM	x30	x25	x16	
1/4W	1/2W	$\leq 0.47\Omega$	0.47 $\Omega$ - 0.91 $\Omega$	1 $\Omega$ - 1K $\Omega$	60 sec max
1/2W	1W	$\leq 0.33\Omega$	0.33 $\Omega$ - 1.2 $\Omega$	1 $\Omega$ - 1K $\Omega$	
1W	2W	$\leq 0.33\Omega$	0.33 $\Omega$ - 1.2 $\Omega$	1 $\Omega$ - 1K $\Omega$	
2W	3W	$\leq 0.33\Omega$	0.33 $\Omega$ - 1.2 $\Omega$	1 $\Omega$ - 1K $\Omega$	

## PART NUMBER

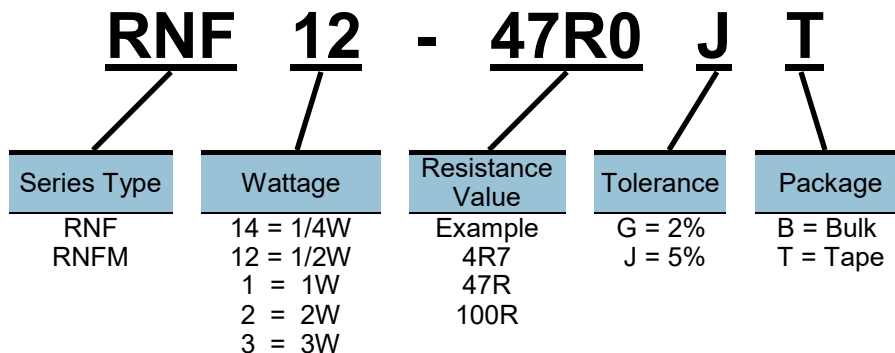

## STANDARD PACKAGING

BULK	1/4W ~ 3W	1,000 pieces	TAPE	1/4W/1/2W mini	5,000 pieces
				1/2W/1W mini	3,000 pieces
				1W/2W mini	2,000 pieces
				2W/3W mini	1,000 pieces

RNF/RNFM Series parts are RoHS & REACH Compliant

# RD-0R Zero Ohm Fixed Resistor

- LOW RESISTANCE, LESS THAN 0.02Ω
- IDEAL FOR AUTOMATIC INSERTION OR CUT AND FORM
- COLOUR CODED BY ONE BLACK BAND



## POWER RATING

1/8W ~ 1/4W

## DIMENSIONS

Colour: Light Brown

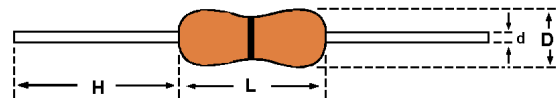

STYLE	DIMENSIONS (mm)			
	L	D	H	d
RD18	3.3 ± 0.4	1.8 ± 0.3	29 ± 2	0.48 ± 0.03
RD14	6.3 ± 0.5	2.3 ± 0.3	28 ± 2	0.58 ± 0.03

## ELECTRICAL CHARACTERISTICS

Power Rating at 70°C	0.12 W	0.25 W
STYLE	RD18	RD14
Current Rating 50°C 75°C 180°C	4A 5A 10A	5A 6A 12A
Insulation Resistance	10,000MΩ - Dry, 100MΩ - Wet	
Body material	Ceramic Body with Metal Film	
Dielectric Withstanding Voltage	Atmospheric - 500V rms, Reduced - 325V rms	

Also available in 1/2W, 1W on special order.

## PART NUMBER

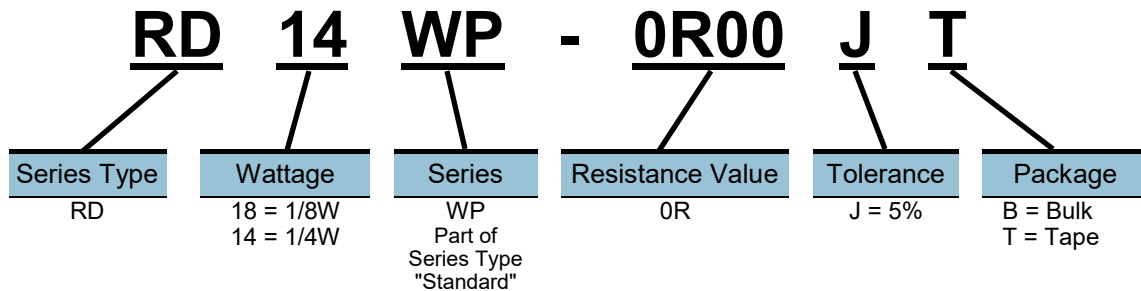

## STANDARD PACKAGING

BULK 1/8W ~ 1/4W 200 pieces

TAPE 1/8W, 1/4W 5,000 pieces

RD Series parts are RoHS & REACH Compliant



# RD Carbon Film Fixed Resistor

- LOW COST
- PROMPT DELIVERY
- EXCELLENT LONG TERM STABILITY
- WIDE RESISTANCE RANGE -  $0.22\Omega \sim 100M\Omega$

## POWER RATING

Standard Type: 1/8W ~ 2W

## DIMENSIONS

Colour: Light Brown - Epoxy Coating

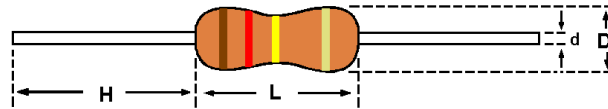

STYLE	DIMENSIONS (mm)			
	L	D	H	d
RD18	$3.3 + 0.7 - 0.2$	$1.8 \pm 0.3$	$29 \pm 2.0$	$0.45 \pm 0.03$
RD14	$6.3 \pm 0.5$	$2.3 \pm 0.3$	$28 \pm 2.0$	$0.55 \pm 0.03$
RD12	$9.0 \pm 0.5$	$3.2 \pm 0.5$	$26 \pm 2.0$	$0.65 \pm 0.03$
RD1	$11.5 \pm 1.0$	$4.5 \pm 0.5$	$35 \pm 2.0$	$0.78 \pm 0.03$
RD2	$15.5 \pm 1.0$	$5.0 \pm 0.5$	$32 \pm 2.0$	$0.78 \pm 0.03$

## ELECTRICAL CHARACTERISTICS

Power Rating at 70°C	0.125 W	0.25 W	0.5 W	1 W	2 W
STYLE	RD18	RD14	RD12	RD1	RD2
Operating Temperature Range	$-55^{\circ}\text{C} \sim +155^{\circ}\text{C}$				
Maximum Working Voltage	150V	250V	350V	450V	500V
Maximum Overload Voltage	300V	500V	700V	1000V	1000V
Dielectric Withstanding Voltage	300V	500V	700V	1000V	1000V
Value Range $\pm 5\%$ *	$1\Omega \sim 10M\Omega$				

\*Resistance range for standard resistance – below or over this resistance on request.

## POWER DERATING CURVE

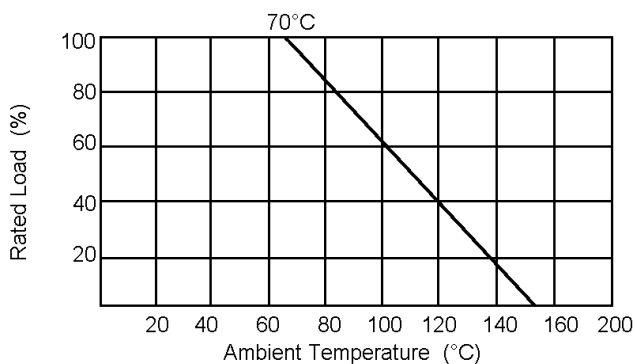

## HOT-SPOT TEMPERATURE

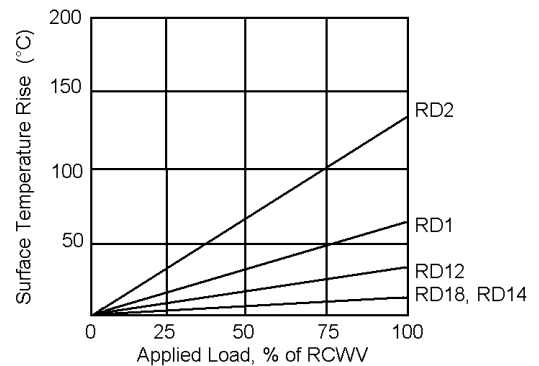

### TEMPERATURE COEFFICIENT (T.C.R.)

STYLE	Maximum Value of Temperature Coefficient ppm/°C		
	Under 100KΩ	100KΩ to 1MΩ	1MΩ to 4M7Ω
RD1, RD2	±350ppm	-0ppm to 500ppm	-0ppm to 1000ppm
RD18, RD14, RD12	+350ppm -500ppm	-0ppm -700ppm	-0ppm -1500ppm

### ENVIRONMENTAL CHARACTERISTICS

PERFORMANCE TEST	TEST METHOD	APPRAISE
Short Time Overload	JIS-C5202 5.5 2.5 times RCWV for 5 seconds	± (0.75% + 0.05Ω)
Temperature Coefficient (TCR)	Resistance value at room temperature (+100°C)	See Figure 1
Dielectric Withstanding Voltage	JIS-C5202 5.7 In V-Block for 60 seconds	By type
Pulse Overload	JIS-C5202 5.8 4 x RCWV for 10,000 cycles (1 seconds on, 25 seconds off)	± (1% + 0.05Ω)
Insulation Resistance	JIS-C5202 5.6 In V-Block	> 10,000MΩ
Load Life	JIS-C5202 7.10 70°C at RCWV for 1,000 hrs (1.5 hr on, 0.5 hr off)	± (3% + 0.05Ω)
Load Life in Humidity	JIS-C5202 7.9 40 ± 2°C, 90 ~ 95% RH at RCWV for 1,000hrs (1.5 hr on, 0.5 hr off)	Less than 100KΩ ± 3% 100KΩ or more ± 5%
Solderability	JIS-C5202 6.5 235 ± 5°C for 2 ± 0.5sec.	95% minimum coverage
Resistance to Solvent	JIS-C5202 6.9 Trichroethane for 1 minute with ultrasonic	No deterioration of coatings and markings
Terminal Strength	Direct load for 10 seconds in the direction of the terminal leads	Tensile ≥ 2.5kg

Rated continuous Working Voltage (RCWV) =  $\sqrt{\text{Power Rating} \times \text{Resistance Value}}$

### PART NUMBER

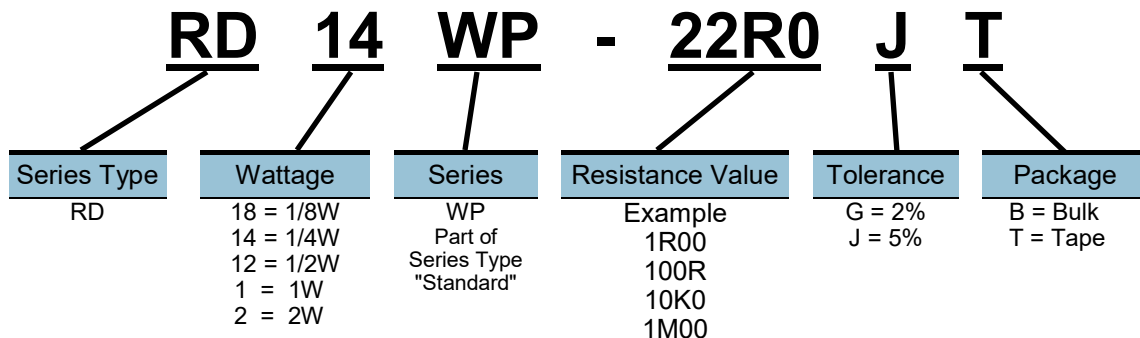

### STANDARD PACKAGING

BULK	1/8W ~ 2W	200 pieces	TAPE	1/8W, 1/4W	5,000 pieces
				1/2W	3,000 pieces
				1W	2,000 pieces
				2W	1,000 pieces

RD Series parts are  
RoHS & REACH Compliant

# RDM Mini-Carbon Film Fixed Resistor

- LOW COST
- PROMPT DELIVERY
- EXCELLENT LONG TERM STABILITY
- WIDE RESISTANCE RANGE -  $0.22\Omega \sim 100M\Omega$

## POWER RATING

Standard Type: 1/4W ~ 3W

## DIMENSIONS

Colour: Pink - Epoxy Coating

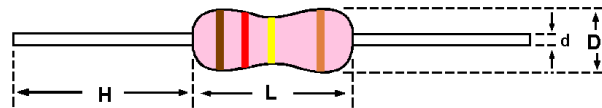

STYLE	DIMENSIONS (mm)			
	L	D	H	d
RDM14	3.3 + 0.7 - 0.2	1.8 ± 0.3	29 ± 2.0	0.45 ± 0.03
RDM12	6.3 ± 0.5	2.3 ± 0.3	28 ± 2.0	0.55 ± 0.03
RDM1	9.0 ± 0.5	3.2 ± 0.5	26 ± 2.0	0.65 ± 0.03
RDM2	11.5 ± 1.0	4.5 ± 0.5	35 ± 2.0	0.78 ± 0.03
RDM3	15.5 ± 1.0	5.0 ± 0.5	32 ± 2.0	0.78 ± 0.03

## ELECTRICAL CHARACTERISTICS

Power Rating at 70°C	0.25 W	0.5 W	1 W	2 W	3 W
STYLE	RDM14	RDM12	RDM1	RDM2	RDM3
Operating Temperature Range	-55°C ~ +155°C				
Maximum Working Voltage	200V	300V	400V	500V	500V
Maximum Overload Voltage	400V	500V	800V	1000V	1000V
Dielectric Withstanding Voltage	400V	500V	800V	1000V	1000V
Value Range ±5%*	1Ω ~ 10MΩ				

\*Resistance range for standard resistance – below or over this resistance on request.

## TEMPERATURE COEFFICIENT (T.C.R.)

STYLE	Maximum Value of Temperature Coefficient ppm/°C		
	Under 100KΩ	100KΩ to 1MΩ	1MΩ to 4M7Ω
RDM2, RDM3	± 350ppm	- 0ppm to 500ppm	- 0ppm to 1000ppm
RDM14, RDM12, RDM1	+ 350ppm - 500ppm	- 0ppm - 700ppm	- 0ppm - 1500ppm

**POWER DERATING CURVE**

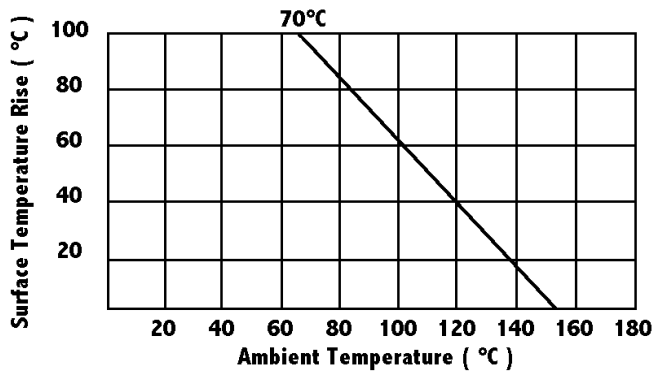

**HOT-SPOT TEMPERATURE**

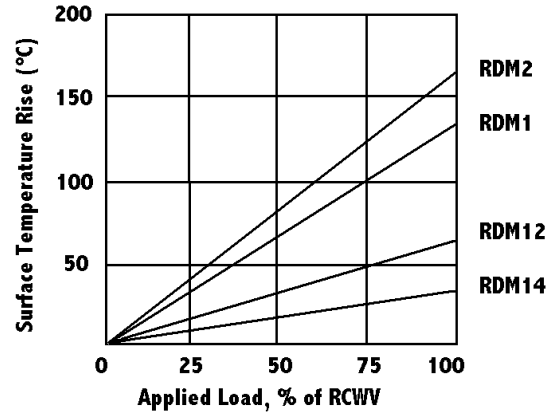

**ENVIRONMENTAL CHARACTERISTICS**

PERFORMANCE TEST	TEST METHOD	APPRAISE
Short Time Overload	JIS-C5202 5.5 2.5 times RCWV for 5 seconds	± (0.75% + 0.05Ω)
Temperature Coefficient (TCR)	Resistance value at room temperature (+ 100°C)	See Fig 1
Dielectric Withstanding Voltage	JIS-C5202 5.7 In V-Block for 60 seconds	By Type
Pulse Overload	JIS-C5202 5.8 4 x RCWV for 10,000 cycles (1 sec on, 25 sec off)	± (1% + 0.05Ω)
Insulation Resistance	JIS-C5202 5.6 In V-Block	> 10,000MΩ
Load Life	JIS-C5202 7.10 70°C at RCWV for 1,000 hrs (1.5 hr on, 0.5 hr off)	± (3% + 0.05Ω)
Load Life in Humidity	JIS-C5202 7.9 40 ± 2°C, 90 ~ 95% RH at RCWV for 1,000 hrs (1.5 hr on, 0.5 hr off)	Less than 100KΩ ± 3% 100KW or more ± 5%
Solderability	JIS-C5202 6.5 235 ± 5°C for 2 ± 0.5seconds	95% minimum coverage
Resistance to Solvent	JIS-C5202 6.9 Trichroethane for 1 min. with ultrasonic	No deterioration of coatings and markings
Terminal Strength	Direct load for 10 seconds in the direction of the terminal leads	Tensile ≥ 2.5kg

**PART NUMBER**

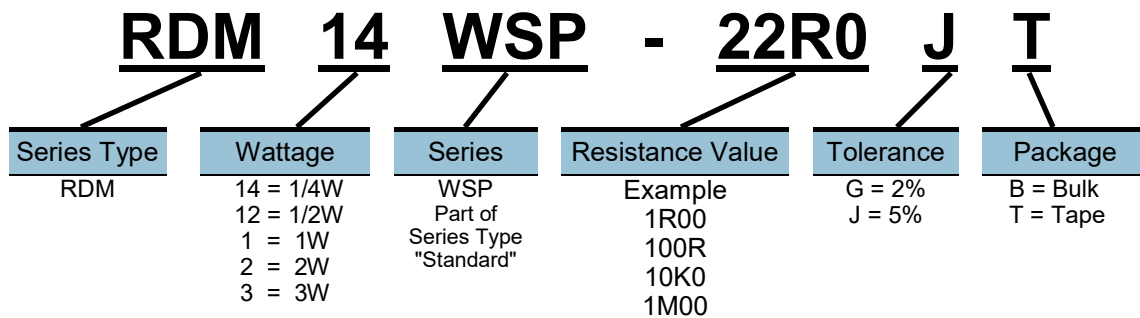

**STANDARD PACKAGING**

BULK	1/4W ~ 3W	200 pieces	TAPE	1/4W, 1/2W	5,000 pieces
				1W	3,000 pieces
				2W	2,000 pieces
				3W	1,000 pieces

RDM Series parts are RoHS & REACH Compliant

# RDF Carbon Film Flameproof Resistor

- LOW COST
- PROMPT DELIVERY
- EXCELLENT LONG TERM STABILITY
- WIDE RESISTANCE RANGE -  $0.22\Omega \sim 100M\Omega$
- COMPLETE FLAMEPROOF CONSTRUCTION UL-1412

## POWER RATING

Standard Type: 1/4W ~ 2W

## DIMENSIONS

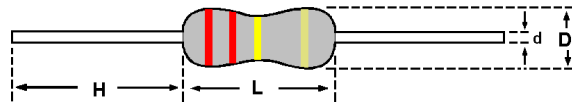

STYLE	DIMENSIONS (mm)			
	L	D	H	d
RDF14B	$6.3 \pm 0.5$	$2.3 \pm 0.3$	$28 \pm 2.0$	$0.55 \pm 0.03$
RDF12B	$9.0 \pm 0.5$	$3.2 \pm 0.5$	$26 \pm 2.0$	$0.65 \pm 0.03$
RDF1B	$11.5 \pm 1.0$	$4.5 \pm 0.5$	$35 \pm 2.0$	$0.78 \pm 0.03$
RDF2B	$15.5 \pm 1.0$	$5.0 \pm 0.5$	$32 \pm 2.0$	$0.78 \pm 0.03$

## ELECTRICAL CHARACTERISTICS

Power Rating at 70°C	0.25 W	0.5 W	1 W	2 W
STYLE	RDF14B	RDF12B	RDF1B	RDF2B
Operating Temp. Range	$-55^{\circ}\text{C} \sim +155^{\circ}\text{C}$			
Maximum Working Voltage	250V	350V	450V	500V
Maximum Overload Voltage	500V	700V	1000V	1000V
Dielectric Withstanding Voltage	500V	700V	1000V	1000V
Value Range $\pm 5\%^*$	$1\Omega \sim 10M\Omega$			

\*Resistance range for standard resistance – below or over this resistance on request.

## TEMPERATURE COEFFICIENT (TCR)

STYLE	Maximum Value of Temperature Coefficient ppm/°C		
	Under 100K $\Omega$	100K $\Omega$ to 1M $\Omega$	1M $\Omega$ to 4.7M $\Omega$
RDF1B, RDF2B	$\pm 350\text{ppm}$	- 0ppm - 500ppm	- 0ppm - 1000ppm
RDF14B, RDF12B	+ 350ppm - 500ppm	- 0ppm - 700ppm	- 0ppm - 1500ppm

**POWER DERATING CURVE**

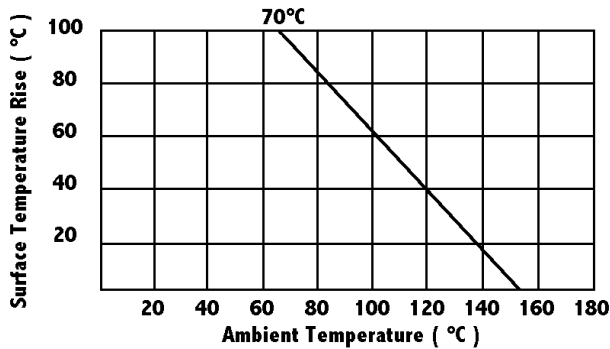

**HOT-SPOT TEMPERATURE**

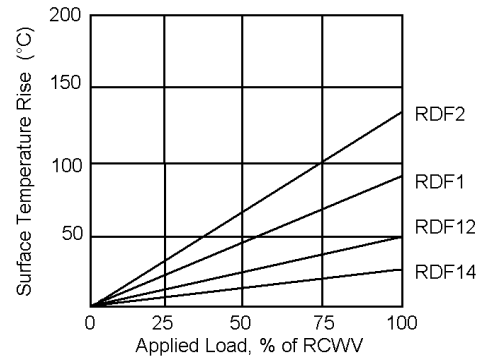

**ENVIRONMENTAL CHARACTERISTICS**

PERFORMANCE TEST	TEST METHOD	APPRAISE
Short Time Overload	JIS-C5202 5.5 2.5 times RCWV for 5 seconds	± (0.75% + 0.05Ω)
Temperature Coefficient (TCR)	Resistance value at room temperature (+100°C)	See Figure 1
Dielectric Withstanding Voltage	JIS-C5202 5.7 In V-Block for 60 seconds	By Type
Pulse Overload	JIS-C5202 5.8 4 x RCWV for 10,000 cycles (1 seconds on, 25 seconds off)	± (1% + 0.05Ω)
Insulation Resistance	JIS-C5202 5.6 In V-Block	> 10,000MΩ
Load Life	JIS-C5202 7.10 70°C at RCWV for 1,000 hrs (1.5 hr on, 0.5 hr off)	± (3% + 0.05Ω)
Load Life in Humidity	JIS-C5202 7.9 40 ± 2°C, 90 ~ 95%RH at RCWV for 1,000 hrs (1.5 hr on, 0.5 hr off)	Less than 100KΩ ± 3% 100KW or more ± 5%
Solderability	JIS-C5202 6.5 235 ± 5°C for 2 ± 0.5sec.	95% minimum coverage
Resistance to Solvent	JIS-C5202 6.9 Trichroethane for 1 min. with ultrasonic	No deterioration of coatings and markings
Terminal Strength	Direct load for 10 seconds in the direction of the terminal leads	Tensile ≥ 2.5kg

**PART NUMBER**

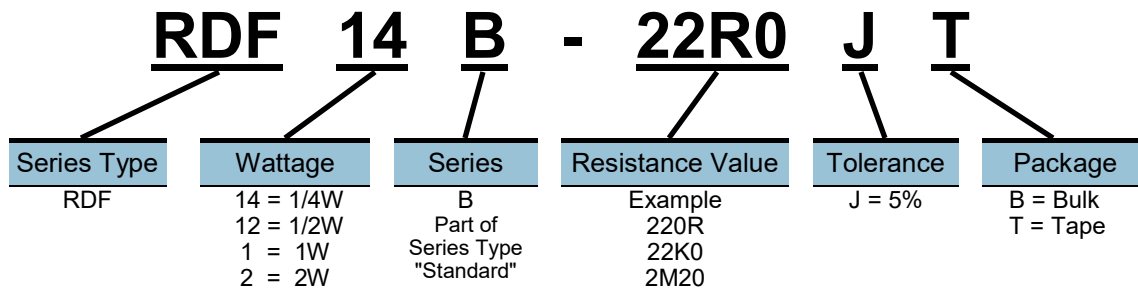

**STANDARD PACKAGING**

BULK	1/8W ~ 2W	200 pieces	TAPE	1/8W, 1/4W	5,000 pieces
				1/2W	3,000 pieces
				1W	2,000 pieces
				2W	1,000 pieces

RDF Series parts are  
RoHS & REACH Compliant

# SSR Surge Safety Resistor

- DESIGNED TO REPLACE CARBON COMPOSITION RESISTORS
- FOR USE IN HIGH SURGE APPLICATIONS AND TO ABSORB HARMFUL SURGE ENERGY

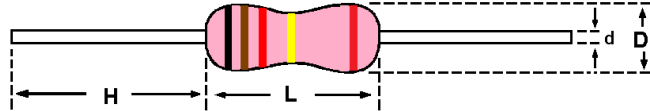

## DIMENSIONS

STYLE	DIMENSIONS (mm)			
	L	D	H	d
SSR 25	6.5 ± 0.7	2.6 ± 0.3	26 ± 3.0	0.55 ± 0.02
SSR51	9.0 ± 1.0	3.2 ± 0.2	26 ± 3.0	0.60 ± 0.03
SSR100	11.0 ± 1.0	4.0 ± 0.5	28 ± 3.0	0.70 ± 0.03
SSR200	15.5 ± 1.0	5.0 ± 0.5	30 ± 3.0	0.80 ± 0.03
SSR300	15.5 ± 1.0	5.5 ± 0.5	30 ± 3.0	0.60 ± 0.03
SSR400	14.0 ± 1.0	8.0 ± 0.5	30 ± 3.0	0.80 ± 0.03
SSR500	24.0 ± 1.0	6.0 ± 0.5	30 ± 3.0	0.80 ± 0.03

## ELECTRICAL CHARACTERISTICS

Power Rating at 70°C*	1/4W	1/2W	1W	2W	3W	4W	5W
STYLE	SSR25	SSR51	SSR100	SSR200	SSR300	SSR400	SSR500
Temperature Range	-55°C ~ +150°C						
Maximum Working Voltage	250V	300V	350V	400V		500V	600V
Maximum Surge Voltage	10KV	15KV	20KV	22.5KV	25KV	30KV	35KV
Temperature Coefficient**	±600ppm/°C	±750ppm/°C	±600ppm/°C			±750ppm/°C	±600ppm/°C
Resistance Tolerance	5%						
Value Range - IEC E24	10Ω ~ 180KΩ	10Ω ~ 220KΩ		10Ω ~ 240KΩ		10Ω ~ 270KΩ	10Ω ~ 330KΩ

\* PLEASE NOTE: When using the SSR Series to replace a carbon composition resistor, it is suggested that the next wattage higher be used. Example: Use the SSR100 to replace a 1/2W carbon composition resistor, use the SSR51 to replace a 1/4W carbon composition resistor/.

\*\* Not applicable to all resistance values. Please contact us regarding the PPM of specific resistance value(s).

## POWER DERATING CURVE

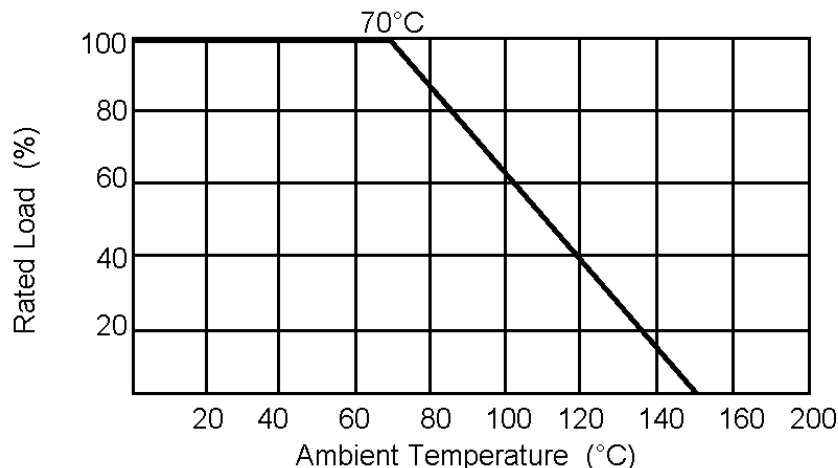

# TYPICAL CHARACTERISTICS

## SINGLE SURGE PERFORMANCE

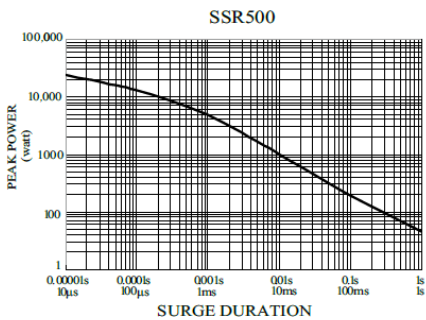
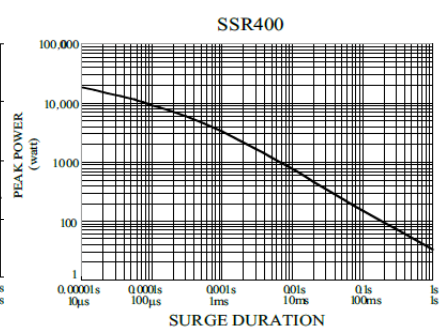
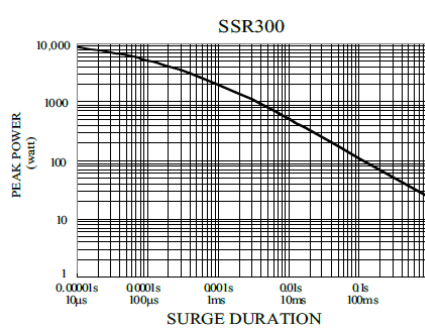
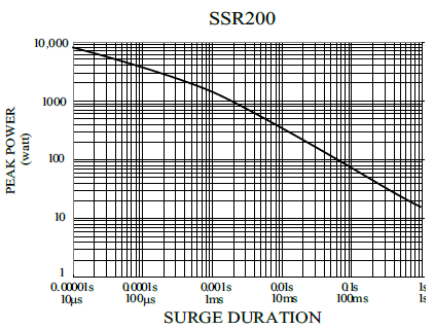
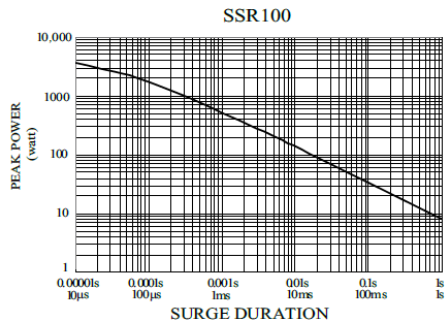
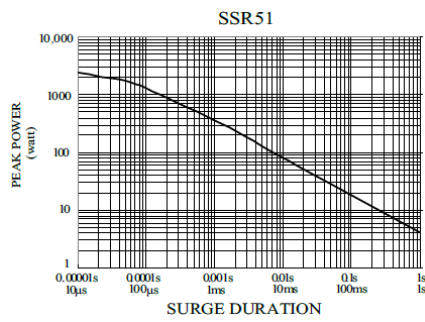
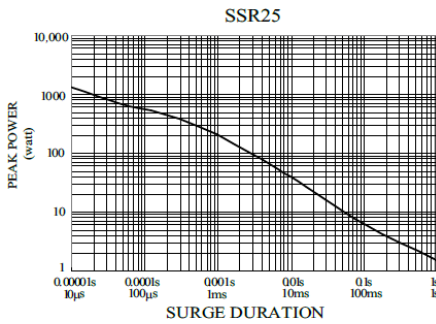

## SURGE POWER DERATING CURVE

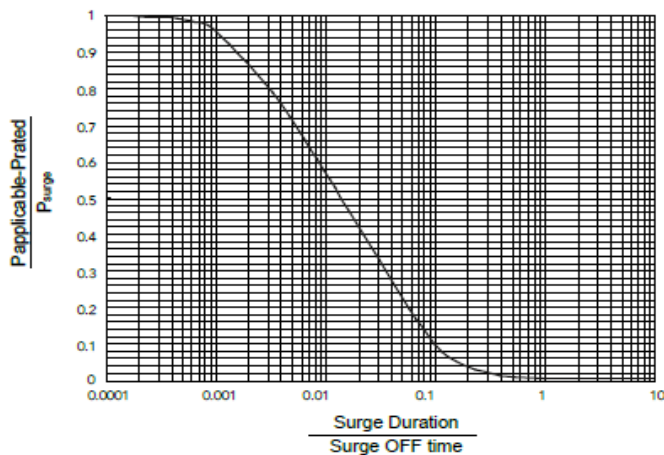

### NOTES:

- SINGLE SURGE PERFORMANCE graph is good for NON REPETITIVE applications operating in an ambient temperature of 70°C or less. For temperatures above 70°C, the graph power must be derated further linearly down to zero at 150°C.
- To determine application surge power in continuous-surge applications:
  1. Identify allowable duration and peak power  $P_{surge}$  of single surge;
  2. Determine ration of surge duration/surge OFF time in application;
  3. Calculate  $P_{applicable}$  backwardly according to Y-axis of SURGE POWER DETATING CURVE.



## PERFORMANCE CHARACTERISTICS

DESCRIPTION	TEST CONDITIONS (IEC 60115-1)	LIMITS															
Short Time Overload	5 seconds 2.5x rated voltage (not over 2x maximum working voltage)	± 1% SSR25 ~ SSR300 ± 2% SSR400 ~ SSR500															
Load Life in Humidity	56 days rated load (not over maximum working voltage) at 40°C ± 2°C and 93% ± 2% relative humidity	± 5%															
Load Life	Rated load (not over maximum working voltage), 1,000 hours with 1.5 hours On, 0.5 hours OFF, at 70°C ± 2°C	± 5%															
Solder Heat Resistance	Leads immersed till 3mm from the body in 260°C ± 5°C solder for 10 seconds ± 1 second	± 1%															
Solderability	Solder area covered after 235°C ± 5°C for 2 seconds ± 0.2 seconds with flux applied	95% minimum coverage															
Vibration	Six hours in each parallel and axial directions with a simple harmonic motion having an amplitude of 1.52mm and 10 to 2000 hz.	± 0.5%															
Thermal Endurance	1,000 hours at 150°C without load	± 2.5%															
Thermal Shock	-55°C for 30 minutes, +150°C for 30 minutes, 5 cycles	± 2% SSR25 ~ SSR300 ± 3% SSR400 & SSR500															
Surge Test	Proprietary test specification: FRC-TR-010113 = $\sqrt{(6000 \times P \times R)}$ DC where P is power rating, R is resistance value, surge voltage is not more than listed at right. Surge spec = 1.2/50µs, Period = 12 seconds, Number of surges = 3000	<table border="1"> <tr> <td>SSR25</td> <td>10KV</td> <td rowspan="7">5%</td> </tr> <tr> <td>SSR51</td> <td>15KV</td> </tr> <tr> <td>SSR100</td> <td>20KV</td> </tr> <tr> <td>SSR200</td> <td>22.5KV</td> </tr> <tr> <td>SSR300</td> <td>25KV</td> </tr> <tr> <td>SSR400</td> <td>30KV</td> </tr> <tr> <td>SSR500</td> <td>35KV</td> </tr> </table>	SSR25	10KV	5%	SSR51	15KV	SSR100	20KV	SSR200	22.5KV	SSR300	25KV	SSR400	30KV	SSR500	35KV
SSR25	10KV	5%															
SSR51	15KV																
SSR100	20KV																
SSR200	22.5KV																
SSR300	25KV																
SSR400	30KV																
SSR500	35KV																

## PART NUMBER

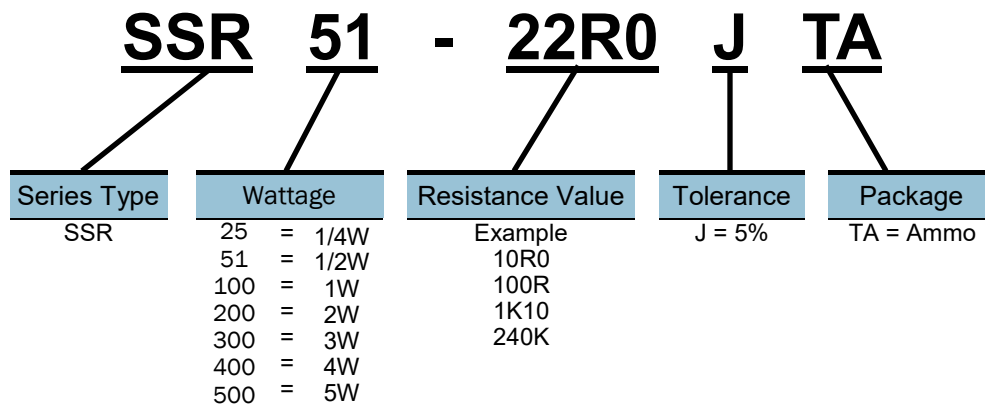

## STANDARD PACKAGING

BULK N/A

TAPE	1/4W~1/2W	2,000 pieces
	1W	1,000 pieces
	2W~4W	500 pieces
	5W	250 pieces

SSR Series parts are RoHS & REACH Compliant
--

# JPW Jumper Wire

Sannohm's Jumper Wire or Crossovers, as they are sometimes called, are basically interconnection devices between points on a printed circuit board (PCB). Normal reasons for use are:

- Inability to connect two points on a PCB due to other circuit paths which must be crossed over.
- An after-the-fact design change that requires new point connections.
- Circuit tuning by changing point connections.

Jumper wires offer a quick, simple, low cost solution to these problems. They are especially suited for automatic machine insertion on lead tape, or available in all packaging styles including precut and formed leads for manual insertion. Contact S-P International for additional information.

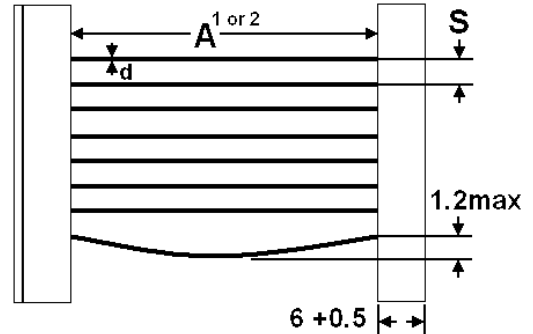

## DIMENSIONS

STYLE	DIMENSIONS (mm)				
	A1	A2	S	d	Current Rating
JPW-05	52.4 ± 1	26 <sup>+1</sup> / <sub>0</sub>	5 ± 0.2	0.5 ± 0.05	6 A @ 70°C
JPW-08	52.4 ± 1	26 <sup>+1</sup> / <sub>0</sub>	5 ± 0.2	0.6 ± 0.05	7.5 A @ 70°C
JPW-07	52.4 ± 1	26 <sup>+1</sup> / <sub>0</sub>	5 ± 0.2	0.7 ± 0.05	8.5 A @ 70°C
JPW-08	52.4 ± 1	26 <sup>+1</sup> / <sub>0</sub>	5 ± 0.2	0.8 ± 0.05	10 A @ 70°C

## ELECTRICAL CHARACTERISTICS

Material of Jumper Wire	Soft Copper with Tin Plating
Conductor Resistance	0.54mΩ/cm
Wire Diameter	±0.03%
Tension Strength	CNS 656 24kgs ± 4kg/mm <sup>2</sup>
Extension Rate	CNS 656 28% ± 2%
Conductivity	Minimum 96%
Twisting Strength	CNS 360°, 2 cycles
Solderability	JIS-5012-C5033 235° ± 5°, 3 seconds, Coverage 95%
Element of Plating	Tin 99 ~ 100%, Lead 0% (or to customer requirement)
Thickness of Plating	5u ± 2u
Appearance	Smooth & Silver coloured

## PART NUMBER

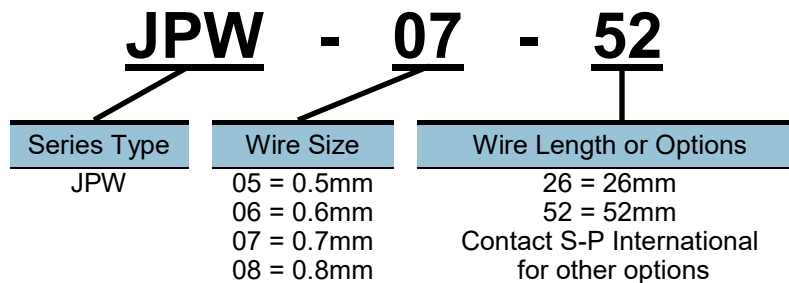

## STANDARD PACKAGING

TAPE 10,000 pieces

JPW Series parts are  
RoHS & REACH Compliant

# SN SIP Resistor Network (Not For New Design)

- AVAILABLE IN 4 TO 14 PIN PACKAGES FOR DESIGN FLEXIBILITY
- LOW PROFILE IS COMPATIBLE WITH DIPs
- HIGH PURITY ALUMINA SUBSTRATE FOR SUPERIOR HEAT DISSIPATION
- LASER MARKING FOR PERMANENT IDENTIFICATION
- AVAILABLE IN BOTH "COMMON BUS" AND "ISOLATED" CONFIGURATIONS
- ZERO OHM JUMPER is AVAILABLE

## DIMENSIONS

STYLE	DIMENSIONS (mm)					
	L	D	H	d	e	f
SNA	as below	2.5	5.08	0.25	2.54	3.5 ±0.5
SNB	as below	2.5	5.08	0.25	2.54	3.5 ±0.5

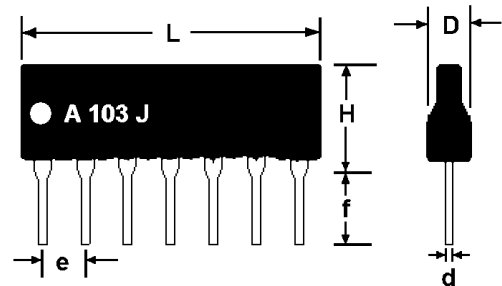

Number of Pins	4	5	6	7	8	9	10	11	12	13	14
Length	10.41	12.95	15.49	18.03	20.57	23.11	25.65	28.19	30.73	33.27	35.81

## ELECTRICAL CHARACTERISTICS

STYLE	SNA	SNB
Power Rating at 70°C (per Element)*	0.125W	0.20W
Maximum Working Voltage	150V	
Dielectric Withstanding Voltage	500V rms	
Temperature Coefficient	± 100ppm/°C (± 250ppm/°C for < 50Ω or ≥ 2.2MΩ)	
Operating Temperature Range	-55°C to +125°C	
Resistance Range**	2.2Ω ~ 2.2MΩ	
Resistance Tolerance	± 1%, ± 2%, ± 5%	

\*Total power rating per network = power rating per element times the number of elements

\*\*Resistance range for standard resistance - below or over this resistance on request

## POWER DERATING CURVE

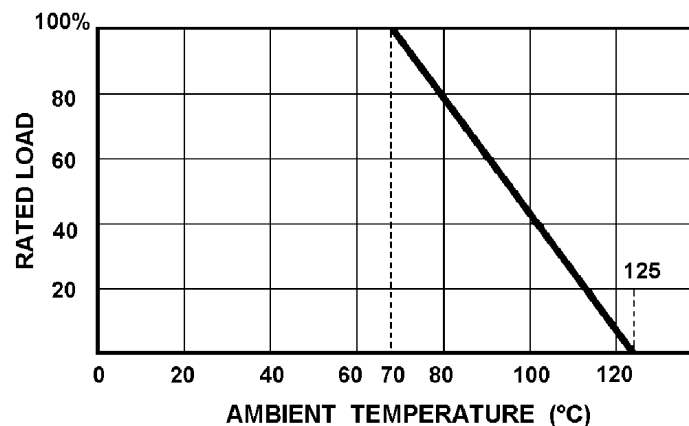

**SCHEMATIC**

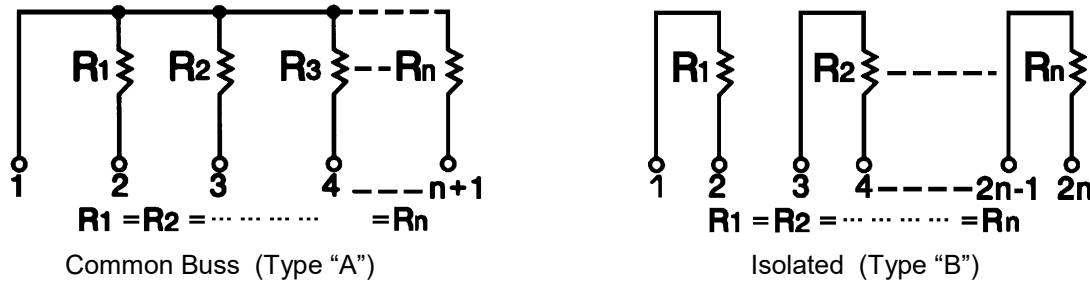

Other circuit configurations available upon request (Type T, L D & E)

**ENVIRONMENTAL CHARACTERISTICS**

DESCRIPTION	TEST METHOD	APPRAISE
Temperature Coefficient	MIL-STD-202F, Method 304	-55°C to +125°C, by Type
Thermal Shock	MIL-STD-202F, Method 107	5 cycles, -55°C to +125°C (Step by Step 2min.) ± (0.5% + 0.1Ω)
Insulation Resistance	MIL-R-202F, Method 202	DC for 1 Minute as Show, > 1000MΩ
Short Time Overload	MIL-R-55342D, Para. 4.7.5	2.5 Times RCWV for 5 Seconds ± (1.0% + 0.05Ω)
Dielectric Withstanding Voltage	MIL-STD-202F, Method 301	R.M.S. for 1 Minute, by Type
Low Temperature Operation	MIL-R-55342D, Para 4.7.4	One Hour at -65°C Followed by 45 Minutes RCWV, ± (1% + 0.05Ω)
Resistance to Soldering Heat	MIL-STD-202F, Method 210C	Soldered to Test Board at 260°C for 10 Seconds, ± (0.25% + 0.05Ω)
Moisture Resistance	MIL-STD-202F, Method 106F	42 Cycles. Total 1000 hrs, ± (3% + 0.1Ω)
Life	MIL-STD-202F, Method 108A	1000 Hours at 70°C RCWV Intermittent, ±(2%+0.05Ω)
Solderability	MIL-STD-202F, Method 208G	260°C for 3 seconds, >95% Coverage

Rated continuous Working Voltage (RCWV) =  $\sqrt{\text{Power Rating} \times \text{Resistance Value}}$

**PART NUMBER**

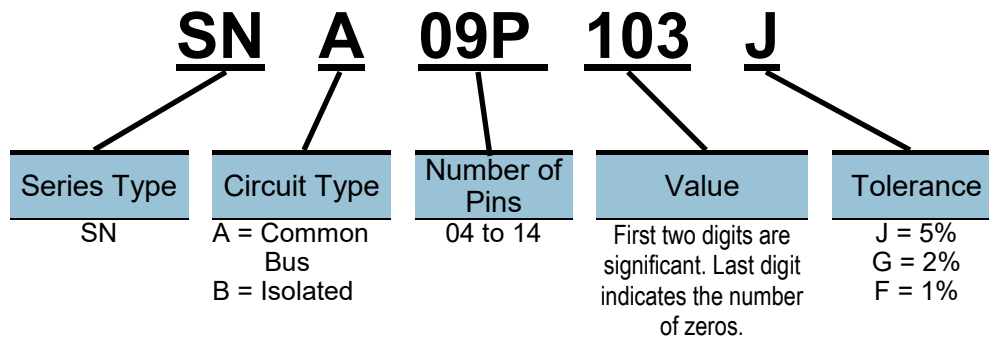

**STANDARD PACKAGING**

Bulk 4 ~ 6 pin - 2,000 pcs  
 7 ~ 10 pin - 1,000 pcs  
 11 ~ 14 pin - 500 pcs

Tape Not Available

MOQ - Call S-P International

SN Series parts are  
 RoHS & REACH Compliant

# SQP Cement Resistor - Axial Lead

- NON-INDUCTIVE SERIES (NSP) AVAILABLE
- SPACE SAVING STAND-OFF TYPE
- SMALL SIZE, HIGH POWER
- METAL GLAZED (HIGH VOLTAGE/HIGH VALUE) CAN BE CUSTOM ORDERED
- ARC & MOISTURE RESISTANT

## POWER RATING

Standard Type: 2W ~ 50W

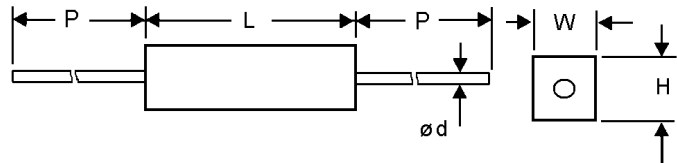

## DIMENSIONS

STYLE	DIMENSIONS (mm)				
	L	W	H	d	P
SQP200	18 ± 0.5	7.0 ± 1.0	7.0 ± 1.0	0.65 ± 0.03	32 ± 3
SQP300	22 ± 0.5	8.0 ± 1.0	8.0 ± 1.0	0.80 ± 0.03	32 ± 3
SQP500	22 ± 0.5	9.0 ± 1.0	9.5 ± 1.0	0.80 ± 0.03	32 ± 3
SQP700	35 ± 0.5	9.0 ± 1.0	9.5 ± 1.0	0.80 ± 0.03	32 ± 3
SQP10A	48 ± 0.5	9.0 ± 1.0	9.5 ± 1.0	0.80 ± 0.03	32 ± 3
SQP15A	48 ± 0.5	12.0 ± 1.0	12.5 ± 1.0	0.80 ± 0.03	32 ± 3
SQP20A	60 ± 0.5	13.0 ± 1.0	14.0 ± 1.0	0.80 ± 0.03	32 ± 3
SQP30A	77 ± 0.5	17.0 ± 1.0	18.0 ± 1.0	0.80 ± 0.03	32 ± 3

\*Specifications for 4W, 25W, 40W & 50W available upon request.

## ELECTRICAL CHARACTERISTICS

Power Rating at 70°C	2 W	3 W	5 W	7 W	10 W	15 W	20 W	30 W
STYLE	SQP200	SQP300	SQP500	SQP700	SQP10A	SQP15A	SQP20A	SQP30A
Operating Temp. Range	-50°C ~ +155°C							
Maximum Working Voltage	150V	300V	300V	500V	500V	500V	500V	1000V
Value Range ± 5% (WW)*	0.1Ω~50Ω			0.1Ω~100Ω				0.1Ω~1KΩ
Value Range ± 5% (MO)*	50Ω~20KΩ	50Ω~33KΩ	50Ω~50KΩ	100Ω~50KΩ		100Ω~150KΩ		
Value Range ±5% (NSP)	0.1Ω~20Ω							
Temperature Coefficient	± 300ppm/°C Wire Wound / ± 200ppm/°C Metal Oxide							

\*Resistance range for standard resistance – below or over this resistance on request

### POWER DERATING CURVE

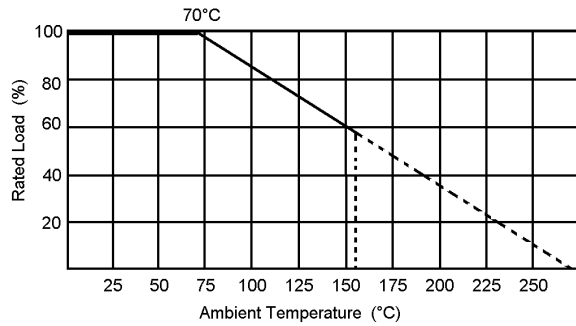

### ENVIRONMENTAL CHARACTERISTICS

PERFORMANCE TEST	TEST METHOD	APPRAISE
Short Time Overload	10 Times RCWV for 5 seconds	± (2%+0.05Ω) WW ± (0.25%+0.05Ω) MO
Temperature Coefficient (TCR)	Resistance value at room temperature +25°C and room temperature +125°C	± 300ppm/°C WW ± 200ppm/°C MO
Temperature Cycling	JIS-C-5202 7.4 -65°C → Room Temp → 150°C → Room Temp for 5 Cycles	± (2%+0.05Ω)
Dielectric Withstanding Voltage	JIS-C-5202 5.7 In V-Block for 60 seconds	Maximum 1000V
Pulse Overload	JIS-C-5202 5.8 4 times RXWV 10,000 cycles (1 second on, 25 seconds off)	Maximum 1500V ± (1%+0.05Ω)
Load Life	JIS-C-5202 7.10 70°C at RCWV for 1000 hrs. (1.5 hrs on, 0.5 hrs off)	± (5% + 0.05Ω)
Load Life in Humidity	JIS-C-5202 7.9 40±2°C, 90~95% RH at RCWV for 1000 Hr (1.5 hrs on, 0.5 hrs off)	± (5% + 0.05Ω)
Solderability	235°C ± 5°C for 2 ± 0.5 seconds	95% Minimum Coverage
Resistance to Solvent	JIS-C-5202 6.9 Trichroethane for 1 min with Ultrasonic	No Deterioration of coatings and markings

Rated Continuous Working Voltage (RCWV) =  $\sqrt{\text{Power Rating} \times \text{Resistance Value}}$

### PART NUMBER

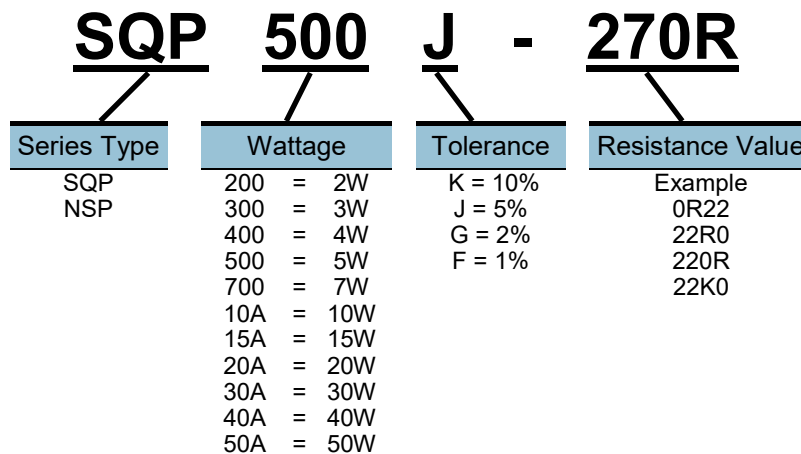

### STANDARD PACKAGING

BULK 1000 pieces

MOQ 1,000 pieces

SQP Series parts are RoHS & REACH Compliant

# SQM Cement Resistor - Radial Lead

- NON-INDUCTIVE SERIES (NSM) AVAILABLE
- SPACE SAVING STAND-OFF TYPE
- SMALL SIZE, HIGH POWER
- SELF EXTINGUISHING
- ARC & MOISTURE RESISTANT

## POWER RATING

Standard Type: 2W ~ 10W

## DIMENSIONS

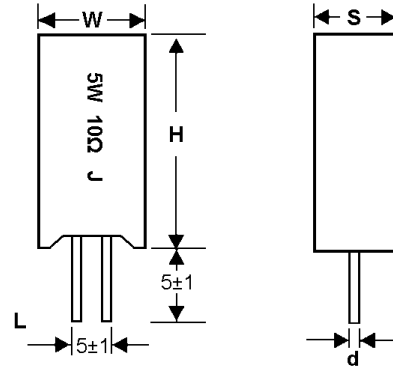

STYLE	DIMENSIONS (mm)			
	H	W	S	d
SQM200	20.5 ± 1.5	11.5 ± 1.5	7.5 ± 1.5	0.75 ± 0.1
SQM300	25.0 ± 1.5	12.5 ± 1.5	8.5 ± 1.0	0.75 ± 0.1
SQM500	25.0 ± 1.5	12.5 ± 1.5	9.0 ± 1.0	0.75 ± 0.1
SQM700	39.0 ± 1.5	12.5 ± 1.5	9.0 ± 1.0	0.75 ± 0.1
SQM10A	51.0 ± 1.5	12.5 ± 1.5	9.0 ± 1.0	0.75 ± 0.1

## ELECTRICAL CHARACTERISTICS

Power Rating at 70°C	2 W	3 W	5 W	7 W	10 W
STYLE	SQM200	SQM300	SQM500	SQM700	SQM10A
Operating Temp. Range	-55°C ~ +155°C				
Maximum Working Voltage	350V	350V	350V	500V	500V
Maximum Overload Voltage	700V	700V	700V	1000V	1000V
Dielectric Withstanding Voltage	700V	700V	700V	1000V	1000V
Special Value Range	0.01Ω ~ 0.09Ω				
Standard Value Range	0.1Ω ~ 33KΩ	0.1Ω ~ 33KΩ	0.1Ω ~ 50KΩ	0.1Ω ~ 50KΩ	0.1Ω ~ 50KΩ
Temperature Coefficient	± 300 ppm / °C				

Non-inductive type (NSM) up to 50Ω only.

## POWER DERATING CURVE

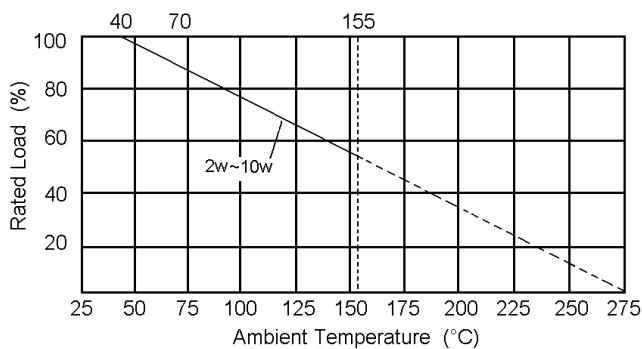

## HOT-SPOT TEMPERATURE

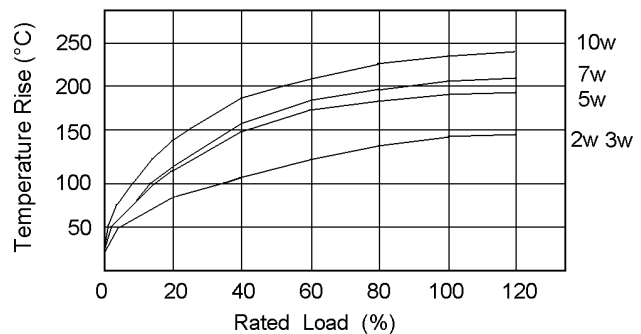

## ENVIRONMENTAL CHARACTERISTICS

PERFORMANCE TEST	TEST METHOD	APPRAISE
Short Time Overload	JIS-C-5202 5.5 2.5 Times RCWV for 5 seconds	± (2% + 0.05Ω)
Temperature Coefficient (TCR)	JIS-C-5202 5.2 -55°C to +155°C	± 330ppm/°C
Temperature Cycling	JIS-C-5202 7.4 -65°C → Room Temperature → 150°C → Room Temperature for 5 cycles	± (2% + 0.05Ω)
Dielectric Withstanding Voltage	JIS-C-5202 5.7 In V-Block for 60 seconds	By type
Pulse Overload	JIS-C-5202 5.8 4 times RXWV 1000 cycles (1 seconds on, 25 seconds off)	± (2% + 0.05Ω)
Insulation Resistance	JIS-C-5202 5.6 In V-Block	> 100MΩ
Load Life	JIS-C-5202 7.10 70°C at RCWV for 1000 hr (1.5 hrs on, 0.5 hrs off)	± (5% + 0.05Ω)
Load Life in Humidity	JIS-C-5202 7.9 40 ± 2°C, 90 ~ 95% RH at RCWV for 1000 hr (1.5 hrs on, 0.5 hrs off)	± (5% + 0.05Ω)
Solderability	JIS-C-5202 6.5 235°C for 5 ± 0.5 seconds	95% Minimum Coverage
Resistance to Soldering Heat	JIS-C-5202 6.4 350°C ± 10°C for 3 ± 0.5 seconds	± (1% + 0.05Ω)
Resistance to Solvent	JIS-C-5202 6.9 Trichroethane for 1min with Ultrasonic	No Deterioration of Coatings and Markings
Terminal Strength	Direct load for 10 sec in direction of the terminal leads	≥ 2.5kg (24.5N)

Rated Continuous Working Voltage (RCWV) =  $\sqrt{\text{Power Rating} \times \text{Resistance Value}}$

## PART NUMBER

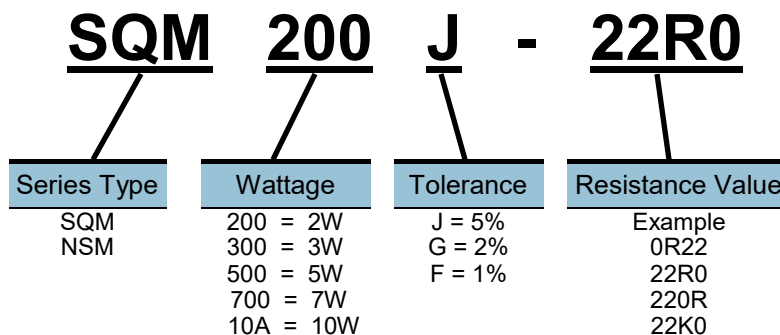

## STANDARD PACKAGING

BULK 1000 pieces      TAPE N/A

SQM Series parts are  
RoHS & REACH Compliant



# SQM Mini-Cement Resistor - Radial Lead

- NON-INDUCTIVE SERIES (NSM) AVAILABLE
- SPACE SAVING STAND-OFF TYPE
- SMALL SIZE, HIGH POWER
- SELF EXTINGUISHING
- ARC & MOISTURE RESISTANT

## POWER RATING

Standard Type: 3W ~ 15W

## DIMENSIONS

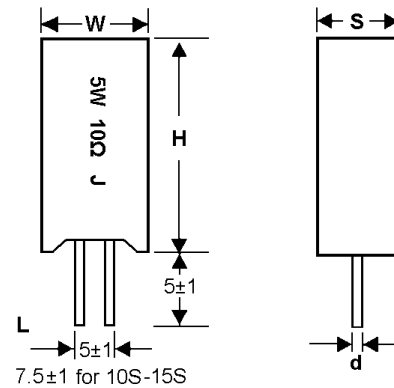

STYLE	DIMENSIONS (mm)			
	H	W	S	d
SQM3S	20.5 ± 1.5	11.5 ± 1.5	7.5 ± 1.5	0.75 ± 0.1
SQM5S	25.0 ± 1.5	12.5 ± 1.5	8.5 ± 1.0	0.75 ± 0.1
SQM10S	35.0 ± 1.5	16.0 ± 1.5	12 ± 1.0	0.75 ± 0.1
SQM14S	35.0 ± 1.5	16.0 ± 1.5	12 ± 1.0	0.75 ± 0.1
SQM15S	51.0 ± 1.5	12.5 ± 1.5	9.0 ± 1.0	0.75 ± 0.1

## ELECTRICAL CHARACTERISTICS

Power Rating at 70°C	3 W	5 W	10 W	14 W	15 W
STYLE	SQM3S	SQM5S	SQM10S	SQM14S	SQM15S
Operating Temp. Range	-55°C ~ +155°C				
Maximum Working Voltage	350V	350V	500V	500V	500V
Maximum Overload Voltage	700V	700V	1000V	1000V	1000V
Dielectric Withstanding Voltage	700V	700V	1000V	1000V	1000V
Special Value Range	0.01Ω ~ 0.09Ω				
Standard Value Range	0.1Ω ~ 33KΩ	0.1Ω ~ 33KΩ	0.1Ω ~ 50KΩ	0.1Ω ~ 50KΩ	0.1Ω ~ 50KΩ
Temperature Coefficient	±300ppm/°C				

Non-Inductive type (NSM) up to 50Ω only.

## POWER DERATING CURVE

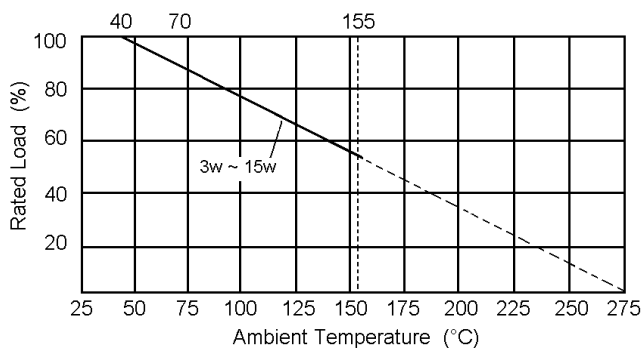

## HOT-SPOT TEMPERATURE

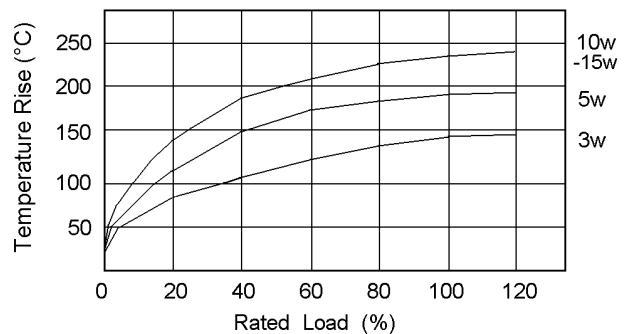

## ENVIRONMENTAL CHARACTERISTICS

PERFORMANCE TEST	TEST METHOD	APPRAISE
Short Time Overload	JIS-C-5202 5.5 2.5 Times RCWV for 5 seconds	± (2% + 0.05Ω)
Temperature Coefficient (TCR)	JIS-C-5202 5.2 -55°C to +155°C	± 330ppm/°C
Temperature Cycling	JIS-C-5202 7.4 -65°C → Room Temperature → 150°C → Room Temperature for 5 cycles	± (2% + 0.05Ω)
Dielectric Withstanding Voltage	JIS-C-5202 5.7 In V-Block for 60 seconds	By Type
Pulse Overload	JIS-C-5202 5.8 4 times RXWV 1000 cycles (1 seconds on, 25 seconds off)	± (2% + 0.05Ω)
Insulation Resistance	JIS-C-5202 5.6 In V-Block	> 100MΩ
Load Life	JIS-C-5202 7.10 70°C at RCWV for 1000 hr (1.5 hrs on, 0.5 hrs off)	± (5% + 0.05Ω)
Load Life in Humidity	JIS-C-5202 7.9 40±2°C, 90 ~ 95% RH at RCWV for 1000 hr (1.5 hrs on, 0.5 hrs off)	± (5% + 0.05Ω)
Solderability	JIS-C-5202 6.5 235°C for 5±0.5 seconds	95% Minimum Coverage
Resistance to Soldering Heat	JIS-C-5202 6.4 350°C±10°C for 3±0.5 Seconds	± (1% + 0.05Ω)
Resistance to Solvent	JIS-C-5202 6.9 Trichroethane for 1min with Ultrasonic	No Deterioration of coatings and markings
Terminal Strength	Direct load for 10 sec in direction of the terminal leads	≥ 2.5kg (24.5N)

$$\text{Rated Continuous Working Voltage (RCWV)} = \sqrt{\text{Power Rating} \times \text{Resistance Value}}$$

## PART NUMBER

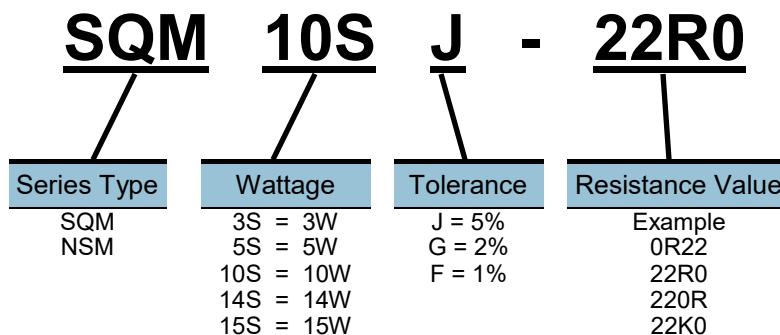

## STANDARD PACKAGING

BULK 200 pieces

TAPE N/A

SQM Series parts are  
RoHS & REACH Compliant

# SQF Rectangular Low Resistance Resistor

- LOW INDUCTANCE
- SPACE SAVING VERTICAL MOUNTING
- THIN LIGHTWEIGHT BODY
- SAFETY FLAMPROOF CONSTRUCTION
- SINGLE AND DUAL RESISTOR FORMATS

## POWER RATING

Standard Type: 3W ~ 5W  
Dual Type: 3W ~ 7W

### Standard Type

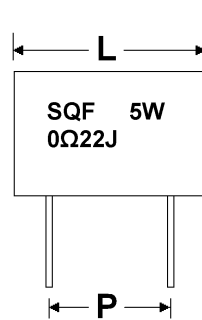

### Dual Type

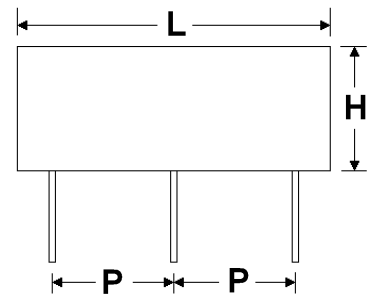

## DIMENSIONS

STYLE	DIMENSIONS (mm)				
	H	L	W	P	d
SQF03	13 ± 1.5	13 ± 1.5	5 ± 1.0	10 ± 1.0	0.8 ± 0.05
SQF33	13 ± 1.5	26 ± 1.5	5 ± 1.0	10 ± 1.0	0.8 ± 0.05
SQF05	18 ± 1.5	14 ± 1.5	5 ± 1.0	10 ± 1.0	0.8 ± 0.05
SQF55	18 ± 1.5	26 ± 1.5	5 ± 1.0	10 ± 1.0	0.8 ± 0.05
SQF77	20 ± 1.5	26 ± 1.5	5 ± 1.0	10 ± 1.0	0.8 ± 0.05

## ELECTRICAL CHARACTERISTICS

Power Rating at 70°C	3 W	3 W x 2	5 W	5 W x 2	7 W x 2
STYLE	SQF03	SQF33	SQF05	SQF55	SQF77
Operating Temp. Range	-55°C ~ +155°C				
Maximum Working Voltage	350V	350V	350V	350V	350V
Maximum Overload Voltage	700V	700V	700V	700V	700V
Dielectric Withstanding Voltage	700V	700V	700V	700V	700V
Value Range ± 5% *	0.1Ω ~ 1Ω				
Temperature Coefficient	±350ppm/°C				

## POWER DERATING CURVE

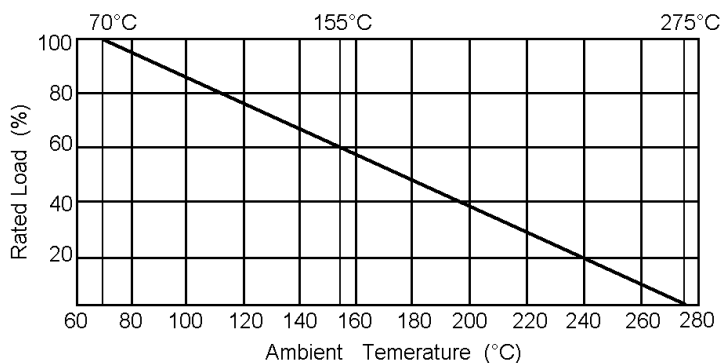

## ENVIRONMENTAL CHARACTERISTICS

PERFORMANCE TEST	TEST METHOD	APPRAISE
Short Time Overload	JIS-5201-1 2.5 times RCWV for 5 seconds	±2%
Temperature Coefficient (TCR)	JIS-C-5201-1 Room temperature / +100°C up	±350ppm/°C
Load Life	JIS-5201-1 70°C ± 2°C for 1000 hr (1.5 hrs on, 0.5 hrs off)	±5%
Moisture Resistance	JIS-5201-1 40 ± 2°C, 90 ~ 92% RH for 1,000 hr (1.5 hrs on, 0.5 hrs off)	±5%
Solderability	JIS-5201-1 235°C ± 5°C for 2 ± 0.5 seconds	75% minimum coverage
Resistance to Soldering Heat	JIS-5201-1 260°C ± 5°C for 10 ± 1 Seconds	±2%
Resistance to Solvent	JIS-5201-1 After immersing the Sample in I.P.A. for 60 seconds ± 10 seconds, the resistor surface should be rubbed with absorbent cotton 10 times	No visible damage of coatings and markings
Terminal Strength	Direct Load : 10N for 10 seconds Bending Test : 5N 90° 2 times	No mechanical damage

Rated Continuous Working Voltage (RCWV) =  $\sqrt{\text{Power Rating} \times \text{Resistance Value}}$

## PART NUMBER

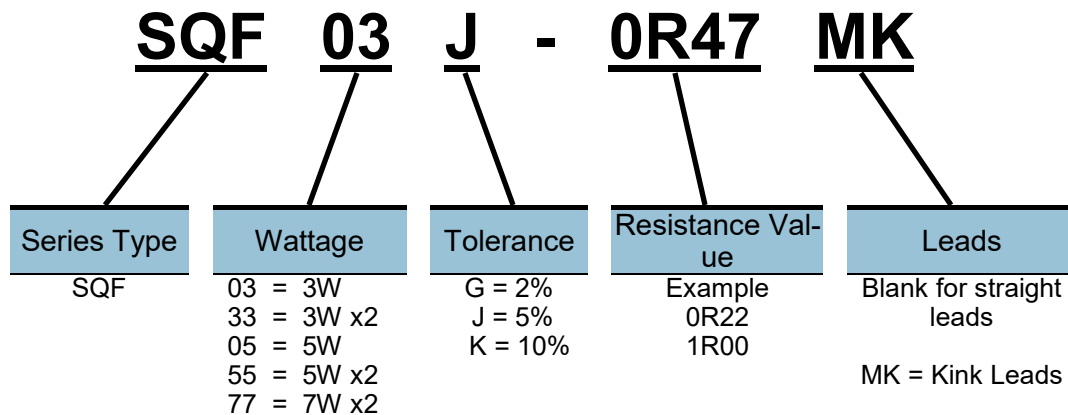

## STANDARD PACKAGING

BULK    600 pieces                      TAPE    N/A

SQF Series parts are  
RoHS & REACH Compliant

# KNPxWS Mini-Wirewound Resistor

- SMALLER SIZE THAN KNP SERIES
- EXCEPTIONAL LONG-TERM STABILITY
- NON-INDUCTIVE SERIES AVAILABLE (NKN)
- EXCEEDS CARBON COMP MIL-R-11 PERFORMANCE
- COMPLETE FLAMEPROOF CONSTRUCTION - MIL-R-22684B
- 5% STANDARD TOLERANCE (2% & 1% AVAILABLE)

## POWER RATING

Standard Type: 1W ~ 7W

## DIMENSIONS

NKN has 5 colour bands, the 5th is a Black band.

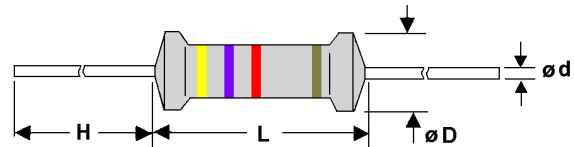

STYLE	DIMENSIONS (mm)			
	L	D	H	d
KNP1WS	9.0 ± 1.0	3.2 ± 1.0	25 ± 3.0	0.6 ± 0.1
KNP2WS	11.0 ± 1.5	4.5 ± 1.0	35 ± 3.0	0.8 ± 0.1
KNP3WS / KNP4WSS	15.0 ± 1.5	5.0 ± 1.0	35 ± 3.0	0.8 ± 0.1
KNP5WS	15.0 ± 1.5	5.0 ± 1.0	35 ± 3.0	0.8 ± 0.1
KNP7WS	24.0 ± 1.5	8.0 ± 1.5	35 ± 3.0	0.8 ± 0.1

## ELECTRICAL CHARACTERISTICS

Power Rating at 70°C	1 W	2 W	3 W	5 W	7 W
STYLE	KNP1WS	KNP2WS	KNP3WS KNP4WSS	KNP5WS	KNP7WS
Operating Temp. Range	-55°C ~ +155°C				
Maximum Working Voltage	250V	300V	300V	300V	300V
Dielectric Withstanding Voltage	300V	400V	400V	400V	400V
Maximum Overload Voltage	350V	450V	450V	450V	450V
Value Range ±5%*	0.1Ω ~ 100Ω	0.1Ω ~ 100Ω	0.1Ω ~ 150Ω	0.1Ω ~ 100Ω	0.1Ω ~ 1.5KΩ
Temperature Coefficient	±300ppm/°C				

\*Resistance range for standard resistance – below or over this resistance on request.  
Non-inductive type (NKN) up to 50Ω only.

## POWER DERATING CURVE

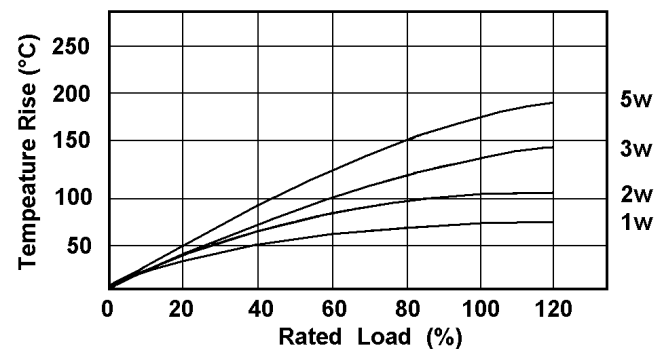
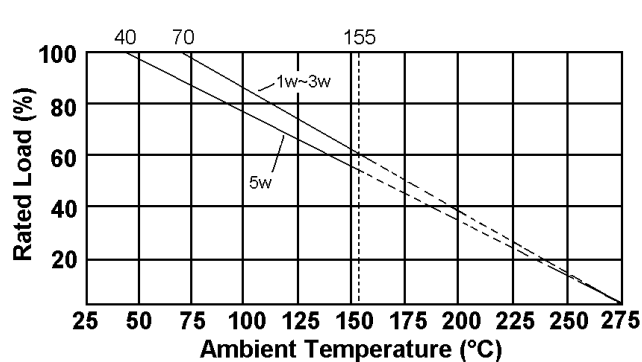

## ENVIRONMENTAL CHARACTERISTICS

PERFORMANCE TEST	TEST METHOD	APPRAISE
Short Time Overload	JIS-C-5202 5.5 2.5 Times RCWV for 5 seconds	± (2% + 0.05Ω)
Temperature Coefficient (TCR)	JIS-C-5202 5.2 -55°C to +155°C	±400ppm/°C
Dielectric Withstanding Voltage	JIS-C-5202 5.7 In V-Block for 60 seconds	By Type
Insulation Resistance	JIS-C-5202 5.6 In V-Block	>100MΩ
Load Life	JIS-C-5202 7.10 70°C at RCWV for 1000 hr (1.5 hrs on, 0.5 hrs off)	± (3% + 0.05Ω)
Load Life in Humidity	JIS-C-5202 7.9 40 ± 2°C, 90 ~ 95% RH at RCWV for 1000 hr (1.5 hrs on, 0.5 hrs off)	± (3% + 0.05Ω)
Solderability	JIS-C-5202 6.5 235°C for 5 ± 0.5 seconds	95% Minimum Coverage
Resistance to Solvent	JIS-C-5202 6.9 Trichroethane for 1min with Ultrasonic	No deterioration of coatings and markings
Terminal Strength	Direct load for 10 seconds in direction of the terminal leads	≥ 2.5kg (24.5N)

Rated Continuous Working Voltage (RCWV) =  $\sqrt{\text{Power Rating} \times \text{Resistance Value}}$

## PART NUMBER

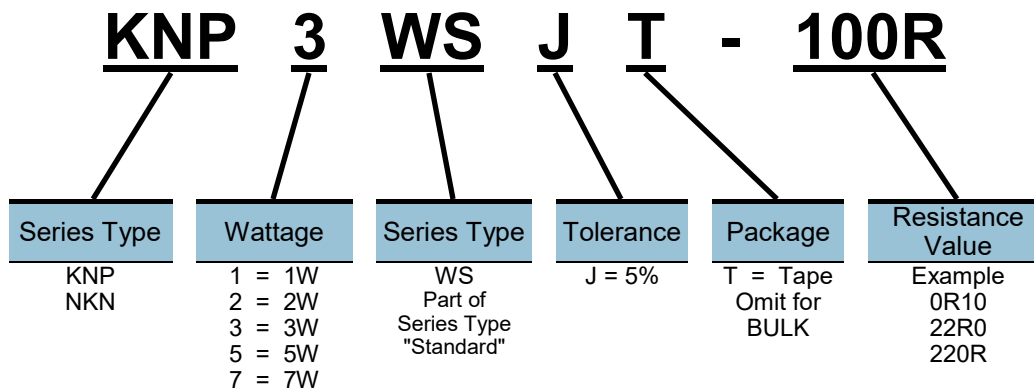

## STANDARD PACKAGING

BULK	Special Order Call	TAPE	1W, 2W 3W, 4W, 5W	1,000 pieces 500 pieces
------	--------------------	------	----------------------	----------------------------

Storage Temperature - 25°C ± 3°C; Humidity <80% RH

KNP Series parts are  
RoHS & REACH Compliant

# KNP Wirewound Resistor

- EXCEPTIONAL LONG-TERM STABILITY
- NON-INDUCTIVE SERIES AVAILABLE (NKN)
- EXCEEDS CARBON COMPOSITION MIL-R-11 PERFORMANCE
- COMPLETE FLAMEPROOF CONSTRUCTION - MIL-R-22684B
- 5% STANDARD TOLERANCE (2% & 1% AVAILABLE)

## POWER RATING

Standard Type: 1/4W ~ 10W

## DIMENSIONS

NKN has 5 colour bands, the 5th is a black band

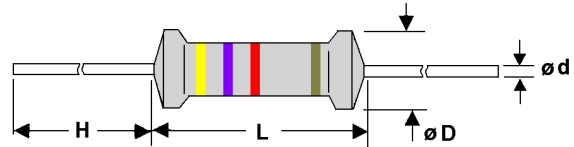

STYLE	DIMENSIONS (mm)			
	L	D	H	d
KNP25	6.0 ± 1.5	2.3 ± 1.0	25 ± 3.0	0.56 ± 0.1
KNP50	9.0 ± 1.5	3.2 ± 1.0	25 ± 3.0	0.6 ± 0.1
KNP100	11.0 ± 1.5	4.5 ± 1.0	35 ± 3.0	0.8 ± 0.1
KNP200	15.0 ± 1.5	5.0 ± 1.0	35 ± 3.0	0.8 ± 0.1
KNP300	17.0 ± 1.5	6.0 ± 1.0	35 ± 3.0	0.8 ± 0.1
KNP500	17.0 ± 1.5	6.0 ± 1.0	35 ± 3.0	0.8 ± 0.1
KNP700	39.0 ± 2.0	8.0 ± 1.5	35 ± 3.0	0.8 ± 0.1
KNP1000	52.0 ± 3.0	8.0 ± 1.5	35 ± 3.0	0.8 ± 0.1

## ELECTRICAL CHARACTERISTICS

Power Rating at 70°C	1/4 W	1/2 W	1 W	2 W	3 W	5 W	7 W	10 W
STYLE	KNP 25	KNP50	KNP100	KNP200	KNP300	KNP500	KNP700	KNP1000
Operating Temperature Range	-55°C ~ +155°C							
Maximum Working Voltage	250V	250V	300V	300V	300V	300V	300V	350V
Dielectric Withstanding Voltage	300V	300V	400V	400V	400V	400V	400V	400V
Maximum Overload Voltage	350V	350V	450V	450V	450V	450V	450V	450V
Value Range ±5%*	0.1Ω ~ 60Ω	0.1Ω ~ 100Ω	0.1Ω ~ 100Ω	0.1Ω ~ 100Ω	0.1Ω ~ 150Ω	0.1Ω ~ 400Ω	0.1Ω ~ 1.5KΩ	0.1Ω ~ 3KΩ
Temperature Coefficient	±300ppm/°C (±25ppm/°C on Special Order)							

\*Resistance range for standard resistance – below or over this resistance on request.  
Non-inductive type (NKN) up to 50W only.

## POWER DERATING CURVE

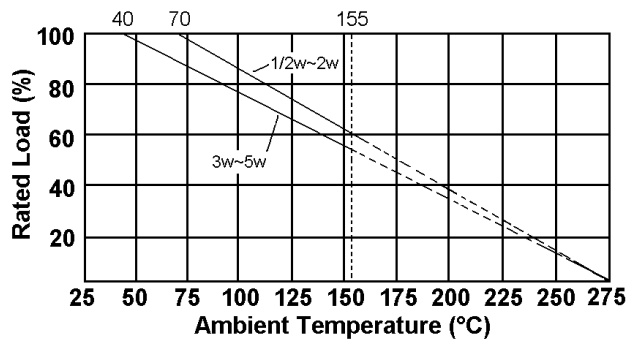

## TEMPERATURE RISE

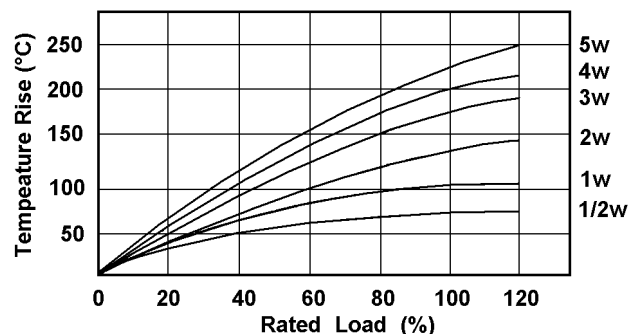

## ENVIRONMENTAL CHARACTERISTICS

PERFORMANCE TEST	TEST METHOD	APPRAISE
Short Time Overload	JIS-C-5202 5.5 2.5 times RCWV for 5 seconds	± (2% + 0.05Ω)
Temperature Coefficient (TCR)	JIS-C-5202 5.2 -55°C to +155°C	±400ppm/°C
Dielectric Withstanding Voltage	JIS-C-5202 5.7 In V-Block for 60 seconds	By type
Insulation Resistance	JIS-C-5202 5.6 In V-Block	>100MΩ
Load Life	JIS-C-5202 7.10 70°C at RCWV for 1000 hr (1.5 hrs on, 0.5 hrs off)	± (3% + 0.05Ω)
Load Life in Humidity	JIS-C-5202 7.9 40 ± 2°C, 90 ~ 95% RH at RCWV for 1000 hr (1.5 hrs on, 0.5 hrs off)	± (3% + 0.05Ω)
Solderability	JIS-C-5202 6.5 235°C for 5 ± 0.5 seconds	95% Minimum Coverage
Resistance to Solvent	JIS-C-5202 6.9 Trichroethane for 1min with Ultrasonic	No deterioration of coatings and markings
Terminal Strength	Direct load for 10 seconds in direction of the terminal leads	≥ 2.5kg (24.5N)

Rated continuous Working Voltage (RCWV) =  $\sqrt{\text{Power Rating} \times \text{Resistance Value}}$

## PART NUMBER

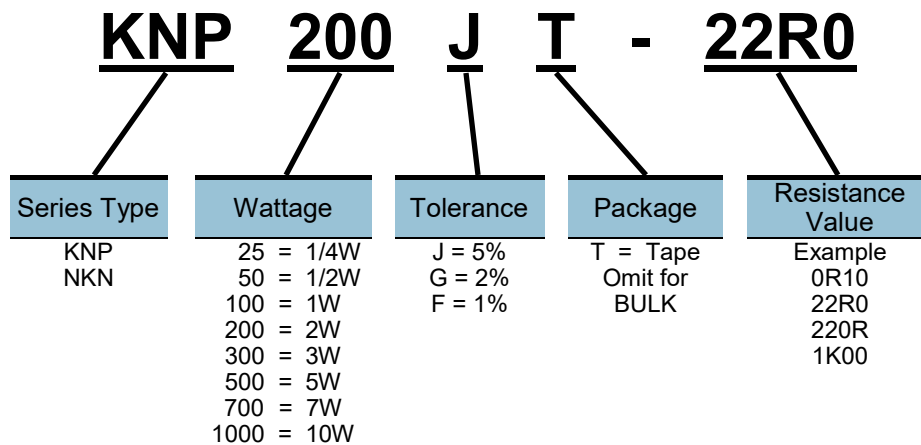

## STANDARD PACKAGING

BULK	7W 250 pieces	TAPE	1/4W	5,000 pieces
	10W 250 pieces		1/2W, 1W	1,000 pieces
			2W, 3W, 5W	500 pieces

Storage Temperature: 25°C ± 3°C; Humidity <80% RH

KNP Series parts are  
RoHS & REACH Compliant



# MR Custom Milliohm Resistor

- SUPER LOW RESISTANCE (1mW~) SUITABLE FOR HIGH POWER CURRENT DETECTION
- PITCHES AND HEIGHTS ADJUSTABLE PER MOUNTING CONDITIONS
- ALL CUSTOM-MADE PRODUCTS
- EASY SOLDERING
- PRODUCTS WITH LEAD-FREE TERMINATIONS MEET EU RoHS



## ELECTRICAL CHARACTERISTICS

SERIES TYPE	SYMBOL	MAX CURRENT	RESISTANCE RANGE	TOLERANCE	T.C.R. PPM/°C Max	RATED AMBIENT TEMP	OPERATING TEMP
MR04	04	2	100mΩ ~ 200mΩ	±1% ±2% ±5% ±10%	±100	+70°C	-40°C to +245°C
MR06	06	3	50mΩ ~ 100mΩ				
MR07	07	4	30mΩ ~ 70mΩ				
MR08	08	4.5	20mΩ ~ 50mΩ				
MR09	09	5	20mΩ ~ 40mΩ				
MR10	10	5.5	15mΩ ~ 30mΩ				
MR11	11	6	15mΩ ~ 20mΩ				
MR12	12	7	10mΩ ~ 20mΩ				
MR13	13	7.5	10mΩ ~ 20mΩ				
MR14	14	8	10mΩ ~ 20mΩ				
MR15	15	9	10mΩ ~ 20mΩ				
MR16	16	9.5	10mΩ ~ 15mΩ				
MR18	18	11	5mΩ ~ 10mΩ				
MR20	20	12	5mΩ ~ 10mΩ				
MR23	23	14	3mΩ ~ 10mΩ				
MR26	26	18	3mΩ ~ 5mΩ				
MR29	29	21	3mΩ ~ 5mΩ				
MR40	40	50	1mΩ ~ 4mΩ				

## PERFORMANCE CHARACTERISTICS

PARAMETER	REQUIREMENT Δ R ±%		TEST METHOD
	Limit	Typical	
Resistance	Within specified tolerance	—	25°C
TCR	Within specified TCR	—	Room temperature +100°C up
Resistance to Soldering Heat	±2.0%	±1.6%	350°C ± 10°C, 3 seconds
Moisture Resistance	±3.0%	±2.7%	Power rating x 1/10, 40°C, 90 ~ 95% RH, 1000 hr
Endurance at 70°C	±5.0%	±3.0%	Rated volt 70°C, 1000 hr, 1.5 hr on, 0.5 hr off

**DIMENSIONS & CONSTRUCTION**

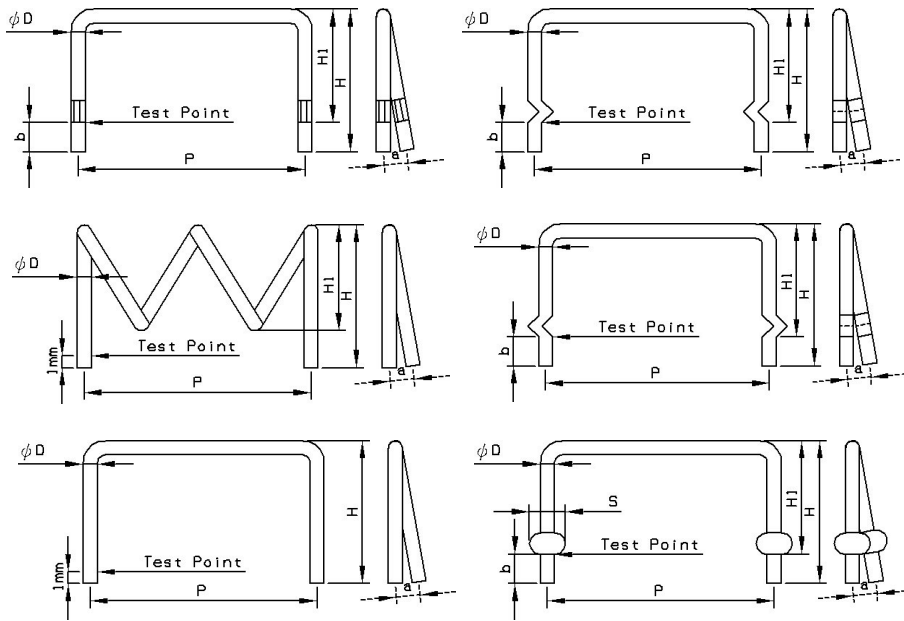

SERIES TYPE	DIMENSIONS (mm)		
	a	b	Ød
MR04	1 Max	3.0 ±0.5	0.4
MR06	1 Max	3.0 ±0.5	0.6
MR07	1 Max	3.0 ±0.5	0.7
MR08	1 Max	3.0 ±0.5	0.8
MR09	1 Max	3.0 ±0.5	0.9
MR10	1 Max	3.0 ±0.5	1.0
MR11	1 Max	3.0 ±0.5	1.
MR12	1 Max	3.0 ±0.5	1.2
MR13	1 Max	3.0 ±0.5	1.3
MR14	1 Max	3.0 ±0.5	1.4
MR15	1 Max	3.0 ±0.5	1.5
MR16	1 Max	3.0 ±0.5	1.6
MR18	1 Max	3.0 ±0.5	1.8
MR20	1 Max	3.0 ±0.5	2.0
MR23	1 Max	3.0 ±0.5	2.3
MR26	1 Max	3.0 ±0.5	2.6
MR29	1 Max	3.0 ±0.5	1.9
MR40	1 Max	3.0 ±0.5	4.0

**POWER DERATING CURVE**

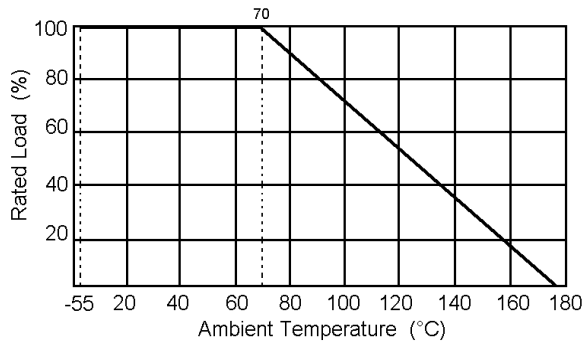

**PART NUMBER**

**MR 09 MB - R050 J 10 - XX**

Series Type	Symbol 04~40	Style	Resistance Value	Tolerance	Insertion Pitch	Surface Treatment
MR	04 - 0.4mm 05 - 0.5mm 10 - 1.0mm 40 - 4.0mm	MB MY MQ MS M MR	Example R0025 R001 R010 R100	F = 1% G = 2% J = 5% K = 10%	10 = 10mm 15 = 15mm 20 = 20mm 25 = 25mm For Custom Contact SPI	Blank = None SN = SN AG = AG CU = CU

**STANDARD PACKAGING**  
BULK

MR Series parts are  
RoHS & REACH Compliant

# TR TO-220 Package Power Resistor

- 20 ~ 50 WATT (AT 25°C CASE TEMPERATURE, HEAT SINK MOUNTED)
- ELECTRICALLY ISOLATED CASE
- NON-INDUCTIVE DESIGN
- MOLDED CASE FOR PROTECTION AND EASY TO MOUNT



## POWER RATING

20W ~ 50W

## DIMENSIONS

STYLE	DIMENSIONS (mm)						
	A	B	C	D	E	F	G
TR20	10.67 max	16.52 max	3.44 max	13.97 max	4.06 max	5.34 max	0.86 max
TR30	10.67 max	16.52 max	3.44 max	13.97 max	4.06 max	5.34 max	0.86 max
TR35	10.41 max	15.00 max	4.82 max	14.70 max	4.00 max	5.33 max	0.86 max
TR50	10.67 max	16.52 max	3.44 max	13.97 max	4.06 max	5.34 max	0.86 max
TR50H	10.67 max	16.62 max	3.44 max	13.97 max	4.06 max	5.34 max	0.86 max

## ELECTRICAL CHARACTERISTICS

Power Rating at 70°C	20 W	30 W	35 W	50 W	50 W
STYLE	TR20	TR30	TR35	TR50	TR50H
Operating Temp. Range	-65°C ~ +150°C				
Working Voltage	350V	420V	350V	350V	420V
Wattage in Free Air at 25°C	3W	2.25W	2.5W	3W	2.25W
Dielectric Strength	1800v				
Insulation Resistance	10GΩ Min				
Resistance Range	Not Specified	0.05Ω ~ 1Ω / 5% ~ 10%			
	± 300ppm	>1Ω ~ 3Ω / 1% ~ 10%			
	± 100ppm ± 200ppm	>3Ω ~ 10Ω / 1% ~ 10%			
	± 50ppm ± 100ppm ± 200ppm	>10Ω ~ 10KΩ / 0.5% ~ 10%			

## POWER DERATING CURVE

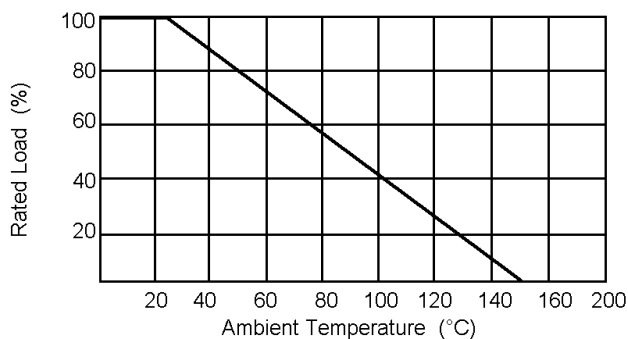

## ENVIRONMENTAL CHARACTERISTICS

PERFORMANCE TEST	TEST METHOD	APPRAISE
Temperature Coefficient (TCR)	Reference 25°C, ΔR taken at +105°C	As per specification
Short Time Overload	2x rated power with applied voltage not to exceed 1.5 x maximum continuous operating voltage for 5 seconds	ΔR ± 0.3%
Load Life	2,000 hours at rated power	ΔR ± 1.0%
Damp Heat with Load	JIS-C5202 7.9 40 ± 2°C, 90 ~ 95% RH at RCWV for 1,000 hrs (1.5 hr on, 0.5 hr off)	ΔR ± 0.5%
Solderability	245 ± 5°C for 3 seconds	90% minimum coverage
Thermal Shock	-65°C~105°C, 100 cycles	ΔR ± 0.3%
Terminal Strength	Pull Test, 2.4N	ΔR ± 0.2%
Vibration, High Frequency	20g Peak	ΔR ± 0.2%

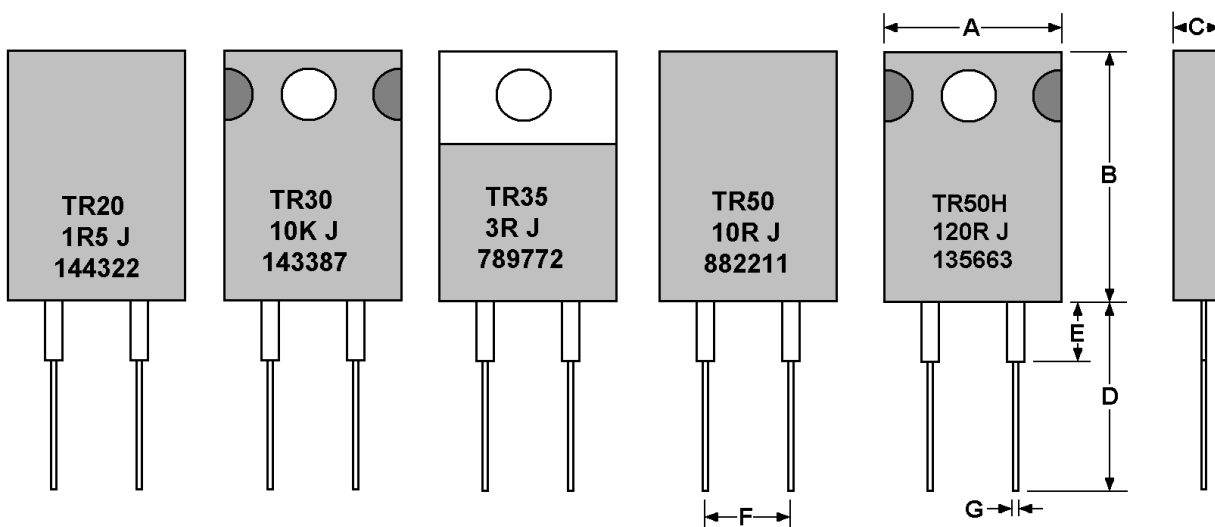

## PART NUMBER

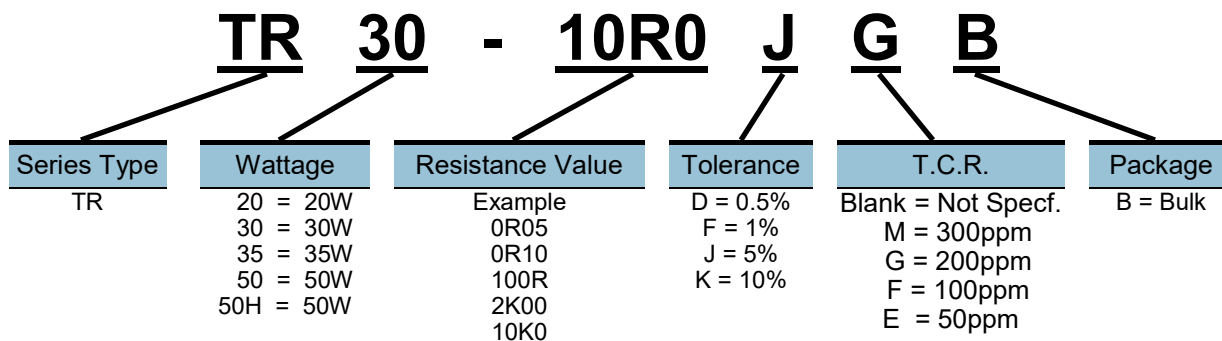

TR Series parts are  
RoHS & REACH Compliant

# TR100 TO-247 Package Power Resistor

- 100 WATT (AT 25°C CASE TEMPERATURE HEAT SINK MOUNTED)
- TO-247 STYLE POWER PACKAGE
- ELECTRICALLY ISOLATED CASE
- NON-INDUCTIVE DESIGN
- SINGLE M3 SCREW MOUNTING TO HEAT SINK

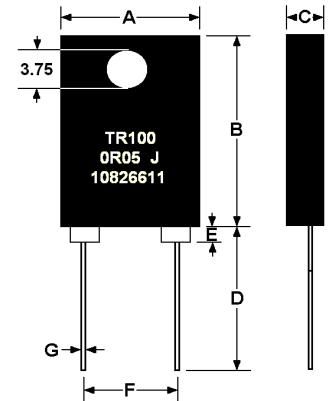

## POWER RATING

100W

## DIMENSIONS

STYLE	DIMENSIONS (mm)						
	A	B	C	D	E	F	G
TR100	16.01 max	20.96 max	5.21 max	15.75 max	3.55 max	10.42 max	1.62 max

## ELECTRICAL CHARACTERISTICS

Power Rating at 70°C	100 W	
STYLE	TR100	
Operating Temp. Range	-65°C ~ +150°C	
Working Voltage	700V	
Wattage in Free Air at 25°C	3.5W	
Dielectric Strength	1800V	
Insulation Resistance	10GΩ Min	
Resistance Range	Not Specified	0.05Ω ~ 1Ω / 5% ~ 10%
	±300ppm	>1Ω ~ 3Ω / 1% ~ 10%
	±100ppm ±200ppm	>3Ω ~ 10 Ω / 1% ~ 10%
	±50ppm ±100ppm ±200ppm	>10Ω ~ 10KΩ / 1% ~ 10%

## POWER DERATING CURVE

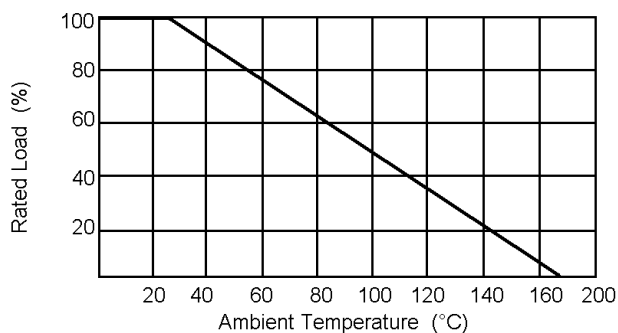

**ENVIRONMENTAL CHARACTERISTICS**

PERFORMANCE TEST	TEST METHOD	APPRAISE
Temperature Coefficient (TCR)	Reference 25°C, ΔR taken at +105°C	As Per Specification
Load Life	2,000 hours at rated power	ΔR ± 1.0%
Momentary Overload	1.5 times rated power and V (DC) ≤ 1.5V max for 5 seconds	ΔR ± 0.5%
Solderability	245 ± 5°C for 3 seconds	90% minimum coverage
Thermal Shock	-65°C ~ 105°C, 100 cycles	ΔR ± 0.5%
Dielectric Strength	1800V AC for 60 seconds	ΔR ± 0.15%
Moisture Resistance	-10°C~+65°C, RH> 90%, cycle for 240hrs	ΔR ± 0.5%
Terminal Strength	Pull Test, 2.4N	ΔR ± 0.2%
Vibration, High Frequency	20g Peak	ΔR ± 0.4%

**PART NUMBER**

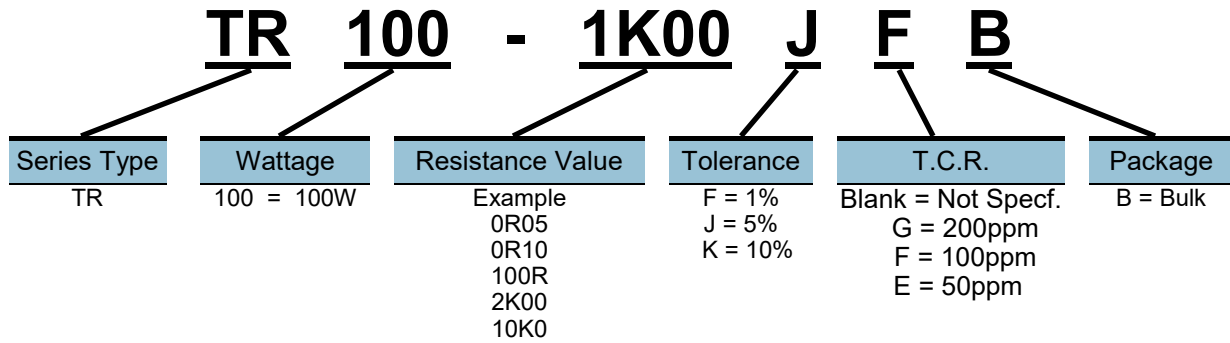

TR100 Series parts are  
RoHS & REACH Compliant

# AH Aluminum Power Resistor

- HIGH POWER RATING, SMALL SIZE, ULTRA PRECISION
- 5% STANDARD TOLERANCE (2% & 1% AVAILABLE)
- HIGH STABILITY AND STRONG CONSTRUCTION
- NON-INDUCTIVE SERIES AVAILABLE (NAH)

## POWER RATING

Standard Type: 5W ~ 250W

## DIMENSIONS

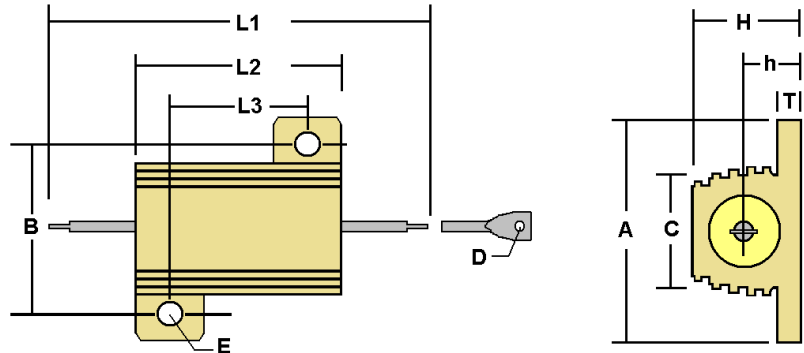

STYLE	DIMENSIONS (mm)										
	L1	L2	L3	A	B	C	D	E	H	h	T
AH5	28.6 ± 2.0	15.3 ± 1.0	11.3 ± 0.8	16.5 ± 1.0	12.4 ± 0.8	8.5 ± 1.0	1.3 ± 0.1	2.4 ± 0.3	8.2 ± 1.0	4.0 ± 1	1.6 ± 0.2
AH10	35.0 ± 2.0	19.0 ± 1.0	14.3 ± 0.8	20.4 ± 1.0	15.9 ± 0.8	11.0 ± 1.0	2.2 ± 0.1	2.4 ± 0.3	10 ± 1.0	5.0 ± 1	2.0 ± 0.2
AH15	35.0 ± 2.0	19.0 ± 1.0	14.3 ± 0.8	20.4 ± 1.0	15.9 ± 0.8	11.0 ± 1.0	2.2 ± 0.1	2.4 ± 0.3	10 ± 1.0	5.0 ± 1	2.0 ± 0.2
AH25	49.0 ± 2.0	27.0 ± 1.0	18.3 ± 0.8	27.2 ± 1.0	19.8 ± 0.8	14.0 ± 1.0	2.2 ± 0.1	3.2 ± 0.3	14 ± 1.0	6.5 ± 1	2.0 ± 0.2
AH50	70.0 ± 2.0	50.0 ± 1.0	39.7 ± 0.8	29.2 ± 1.0	21.5 ± 0.8	16.0 ± 1.0	2.2 ± 0.1	3.2 ± 0.3	16 ± 1.0	7.0 ± 1	2.0 ± 0.2
AH100	139.14	88.9	69.85	71.42	57.15	46.02		4.78	44.45	19.56	4.75
AH250	177.80	114.3		76.20	63.50	53.98		4.78	55.58	24.26	6.38

## ELECTRICAL CHARACTERISTICS

Contact S-P International for 100W & 250W drawings

Power Rating at 70°C	5 W	10 W	15 W	25 W	50 W	100 W	250 W
STYLE	AH5	AH10	AH15	AH25	AH50	AH100	AH250
Operating Temp. Range	-55°C ~ +275°C						
Max Working Voltage - AH	120V	245V	245V	500V	1300V	1900V	2500V
Max Working Voltage - NAH	70V	180V	180V	300V	600V	1340V	1750V
Resistive Range - AH	0.05Ω ~ 3KΩ	0.02Ω ~ 6KΩ	0.02Ω ~ 6KΩ	0.012Ω ~ 15KΩ	0.01Ω ~ 40KΩ	0.4Ω ~ 50KΩ	0.6Ω ~ 80KΩ
Resistive Range - NAH	0.1Ω ~ 1KΩ	0.03Ω ~ 2.3KΩ	0.03Ω ~ 2.3KΩ	0.02Ω ~ 5.5KΩ	0.02Ω ~ 12KΩ	0.12Ω ~ 25KΩ	0.15Ω ~ 40KΩ
Temperature Coefficient	10Ω and up ±30ppm/°C		1Ω to 9.99Ω ±50ppm/°C		Below 1Ω ±90ppm/°C		

## POWER DERATING CURVE

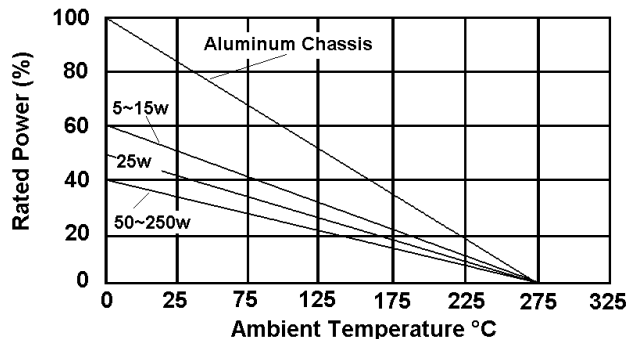

## TEMPERATURE RISE

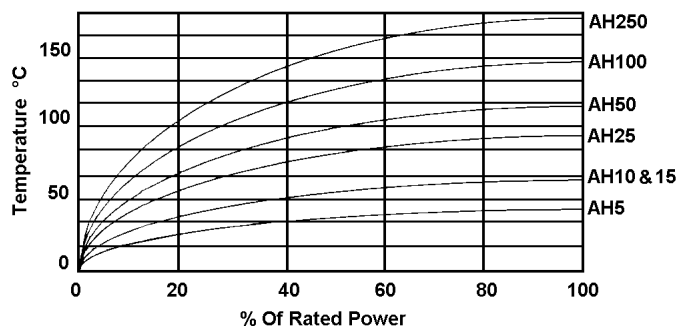

## ENVIRONMENTAL CHARACTERISTICS

PERFORMANCE TEST	TEST METHOD	APPRAISE
Short Time Overload	5 Times Wattage for 5 seconds	± (0.5% + 0.05Ω) max
Moisture Resistance	40°C, 95% RH DC 100v for 500 hr	± (0.5% + 0.05Ω) max
Moisture Load Life	40°C, 95% RH 1/10x Wattage Rating for 1000 hr (1.5 hrs on, 0.5 hrs off)	± (0.5% + 0.05Ω) max
Load Life	Load Rating (Chassis mounted) for 1000 hr (1.5 hrs on, 0.5 hrs off)	± (1.5% + 0.05Ω) max
Vibration	70°C at RCWV for 1000 hr (1.5 hrs on, 0.5 hrs off)	± (0.2% + 0.05Ω) max
Load Life in Humidity	10c/s ~ 50c/s (1 min) 2 hr each of parallel and right angle	± (3% + 0.05Ω)
Dielectric Strength	AH5, AH10, AH25 - 1000v AH50 - 1500v AH100, AH250 - 2500v	± (0.2% + 0.05Ω) max
Insulation Resistance	Under same condition as Dielectric Strength, load 500VDC and measure the insulation R	1,000MΩ min
Terminal Strength	1) Pull Test (30 seconds min) AH5 1kg, AH10 2.3kg, AH25, AH50 4.5kg 2) Torque Test (5 ~ 15 seconds) AH100 27kg-cm, AH250 36kg-cm	± (0.2% + 0.05Ω) max

Rated Continuous Working Voltage (RCWV) =  $\sqrt{\text{Power Rating} \times \text{Resistance Value}}$

## PART NUMBER

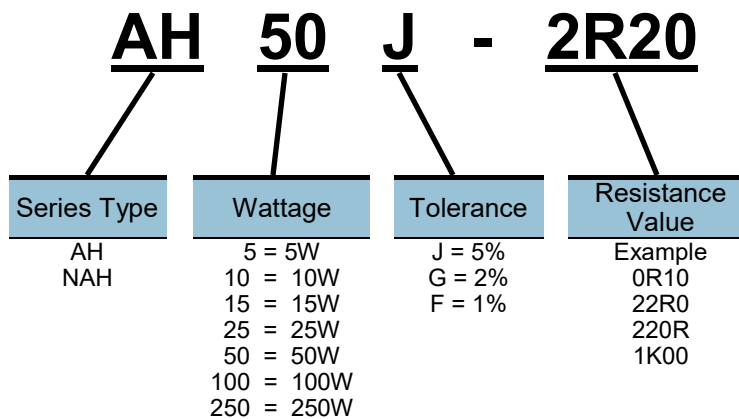

## STANDARD PACKAGING

BULK

AH & NAH Series parts are  
RoHS & REACH Compliant



# CH Power Wirewound Resistor

- HIGH RESISTIVITY TO HEAT
- RESISTANCE VALUE UNCHANGED AFTER LONG USE
- GOOD RESISTIVITY TO SHORT TIME OVERLOAD
- SMALL SIZE AND HIGH POWER LOAD
- MULTI-TERMINAL TYPE AND VARIABLE TYPE AVAILABLE

## DIMENSIONS & RATINGS

STYLE	RESISTANCE RANGE	DIMENSIONS (mm)				"CHS" TYPE				CH Wt (gm)
		L	D	d	W	L1	L2	h	f	
CH10	0.1Ω - 10KΩ	45	12	6	5					12
CH15	0.1Ω - 15KΩ	45	15	8	5				4.1	19
CH20	0.1Ω - 20KΩ	50	19	10	5	66	80	38	4.1	35
CH30	0.1Ω - 30KΩ	75	19	10	5	91	105	38	4.1	45
CH40	0.1Ω - 40KΩ	90	19	10	5	106	120	38	4.1	55
CH50	0.1Ω - 50KΩ	75	30	16	8	105	120	58	5.2	100
CH60	0.1Ω - 60KΩ	90	30	16	8	120	135	58	5.2	120
CH80	0.1Ω - 80KΩ	115	30	16	8	145	160	58	5.2	150
CH100	0.1Ω - 100KΩ	140	30	16	8	170	185	58	5.2	180
CH120	0.1Ω - 120KΩ	163	30	16	8	193	208	58	5.2	220
CH150	0.1Ω - 150KΩ	195	30	16	8	225	240	58	5.2	255
CH200	0.1Ω - 200KΩ	254	30	16	8	284	299	58	5.2	310
CH250	0.1Ω - 250KΩ	303	30	16	8	333	348	58	5.2	400
CH300	0.1Ω - 300KΩ	254	45	28	15					600
CH400	0.1Ω - 400KΩ	330	45	28	15					750
CH500	0.1Ω - 500KΩ	303	55	35	15					1000

## SURFACE TEMP. vs POWER LOAD

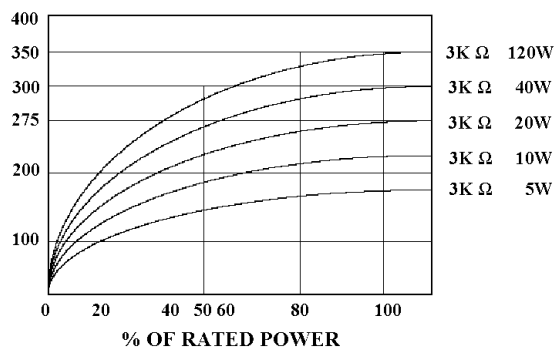

## TEMP vs. TIME (100% LOAD)

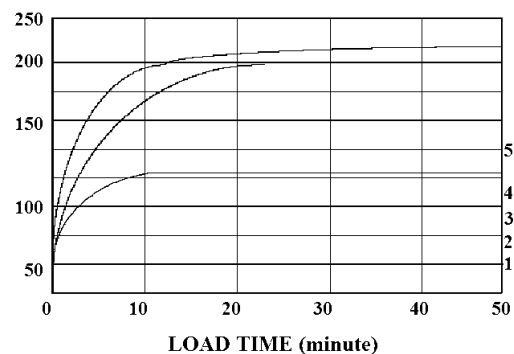

**OUTLINE**

**CH Type**

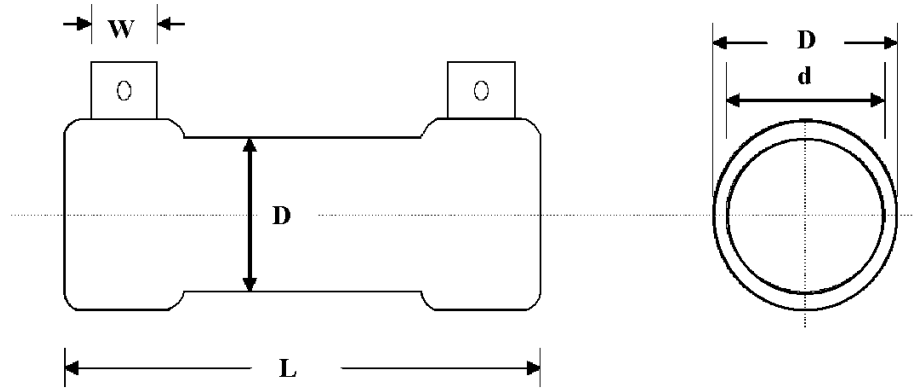

**CHS Type**

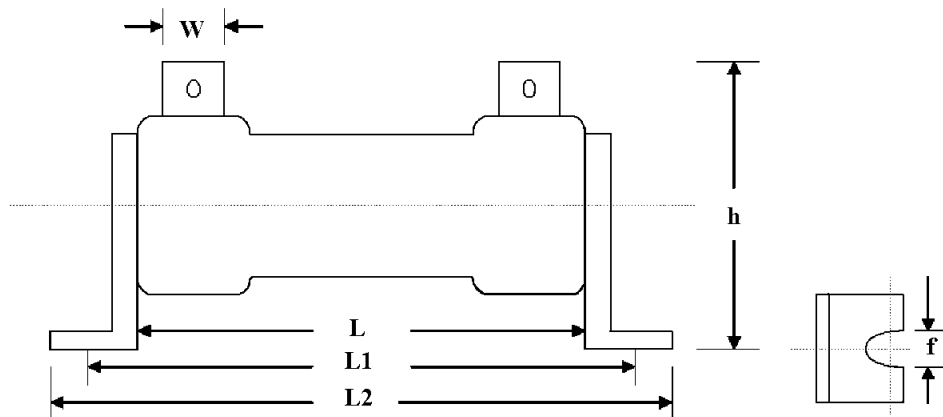

**PART NUMBER**

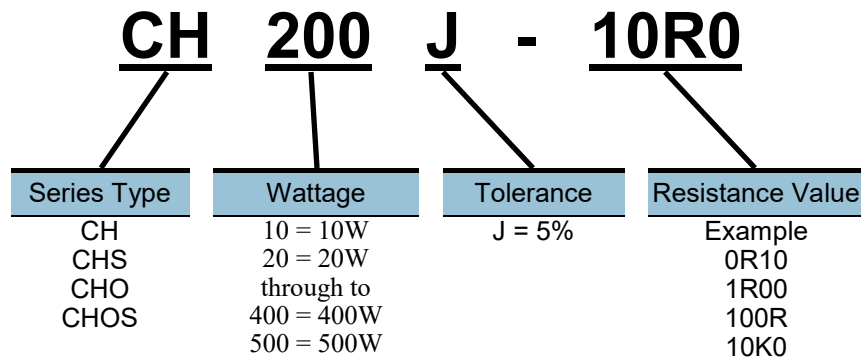

**STANDARD PACKAGING**

BULK - MOQ 100 pcs per value

CH Series parts are  
RoHS & REACH Compliant

# PACKAGING

## TAPED RADIAL LEAD CONFIGURATION

Sannohm and Sanyo-OHM resistors are available in special order radial lead configurations, as well as the standard axial taping for reels and ammo box packaging. The radial lead style is U-Tape. (AVI-SERT and PANA-SERT are available only in bulk at this time). Please note that not all resistor body sizes are available in all styles. U-Tape product is supplied in ammo box packaging. AVI-SERT and PANA-SERT are available in both reel and ammo box packaging.

Radial lead configurations are normally a special order product. Please consult S-P International for details.

### U-Tape

Available body sizes - 1/8W and mini 1/4W

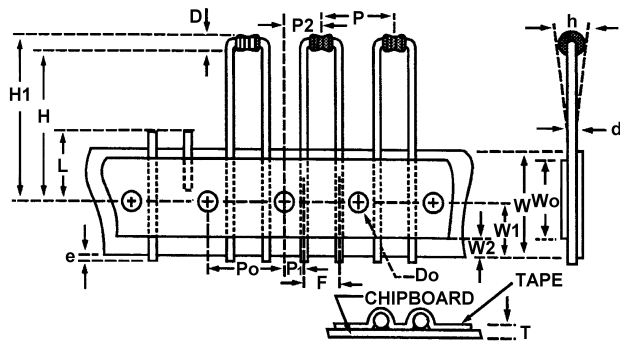

Description	Symbol	Dimension (mm)	Dimension (in.)
Resistor Body Diameter	D	1.8 ± 0.4	0.071 ± 0.016
Resistor Pitch	P	12.7 ± 1.0	0.500 ± 0.039
Sprocket Hole Pitch	PO	12.7 ± 0.5	0.500 ± 0.020
Sprocket Hole Centre to Lead Centre	P1	3.85 ± 0.7	0.152 ± 0.028
Sprocket Hole Centre to Resistor Centre	P2	6.35 ± 1.0	0.250 ± 0.039
Resistor Lead Spacing	F	5.0 ± 0.8	0.197 ± 0.039
Resistor Alignment	h	0 ± 1.0	0 ± 0.039
Chipboard Width	W	18.0 ± 1.0	0.709 ± 0.039
Hold-Down Tape Resistor	W0	12.0 ± 1.0	0.472 ± 0.039
Sprocket Hole Position	W1	9.0 ± 0.5	0.354 ± 0.020
Hold-Down Tape Position	W2	3.0 Max	0.118 Max
Height to Bottom of Resistor	H	21.0 Max	0.827 Max
Lead Protrusion	e	2.0 Max	0.079 Max
Sprocket Hole Diameter	Do	4.0 ± 0.3	0.157 ± 0.012
Thickness (Chipboard And Tape)	T	0.7 ± 0.2	0.028 ± 0.008
Cutout Length	L	2.0 Max	0.790 Max
Height of Resistor	H1	32.25 Max	1.398 Max
Lead wire Diameter	d	0.45 ± 0.03	0.178 ± 0.012

Cumulative Pitch Tolerances Not To Exceed ±1.0mm (±0.039 in.) Over 20 Consecutive Pitches

### TAPED AXIAL LEAD CONFIGURATIONS

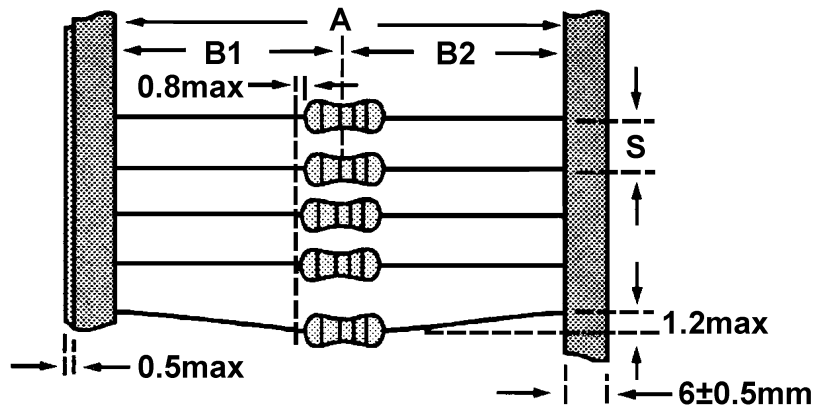

Body Size		Dimension (mm)			Maximum deviation of spacing is 1mm per 10 spacings
Normal	Miniature	A	B1-B2	Spacing	
1/8W	1/4W	52	1.2	5	
		26	1.0		
1/4W	1/2W	52	1.2	5	
		26	1.0		
1/2W	1W	52	1.2	5	
1W	2W	52	1.5	5	
		73			
2W	3W	52	1.5	10	
		73			

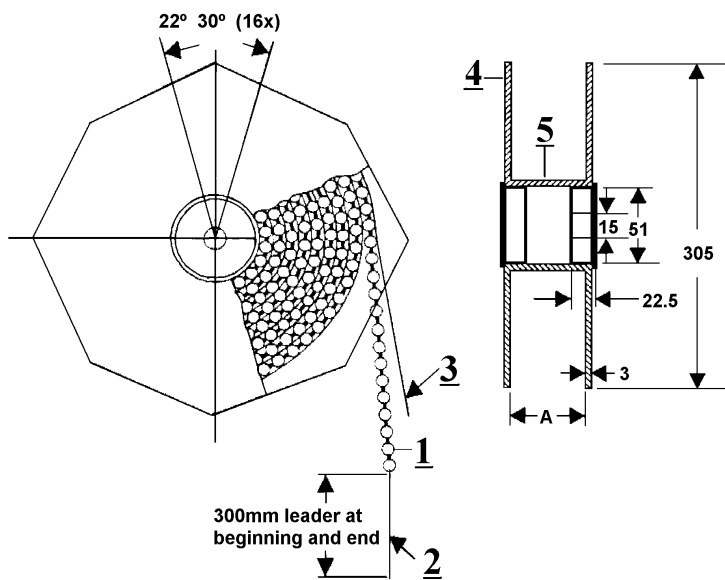

**TAPE & REEL**

- 1 Resistor
- 2 Bandolier
- 3 Paper
- 4 Flange
- 5 Cylinder

**TAPE-AMMO**

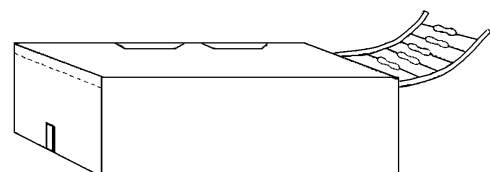

## SPECIAL CONFIGURATIONS – BULK

### M - TYPE

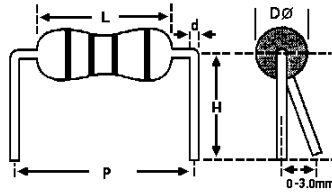

STYLE		DIMENSIONS (mm)				
NORMAL	MINIATURE	P	H	D	L	d
1/8W	1/4W	$5 \pm 1$	$5 \pm 1$	$1.8 \pm 0.3$	$3.3 \pm 0.4$	$0.45 \pm 0.03$
1/4W	1/2W	$10 \pm 1$	$10 \pm 1$	$2.3 \pm 0.5$	$6.3 \pm 0.5$	$0.55 \pm 0.03$
1/2W	1W	$12.5 \pm 1$	$10 \pm 1$	$3.2 \pm 0.5$	$9.0 \pm 0.5$	$0.65 \pm 0.03$
1W	1W	$15 \pm 1$	$12.5 \pm 1$	$4.5 \pm 0.5$	$11.5 \pm 1.0$	$0.78 \pm 0.03$
2W	3W	$20 \pm 1$	$15 \pm 1$	$5.0 \pm 0.5$	$15.5 \pm 1.0$	$0.78 \pm 0.03$

### MB - TYPE

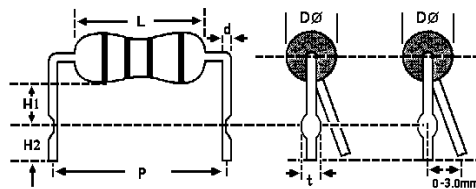

STYLE		DIMENSIONS (mm)						
NORMAL	MINIATURE	P	H1	H2	t	D	L	d
1W	1W	$15 \pm 1$	$10 \pm 1$	$5 \pm 1$	$1.4 \pm 0.2$	$4.5 \pm 0.5$	$11.5 \pm 1.0$	$0.78 \pm 0.03$
2W	3W	$20 \pm 1$	$10 \pm 1$	$5 \pm 1$	$1.4 \pm 0.2$	$5 \pm 0.5$	$15.5 \pm 1.0$	$0.78 \pm 0.03$

### MK - TYPE

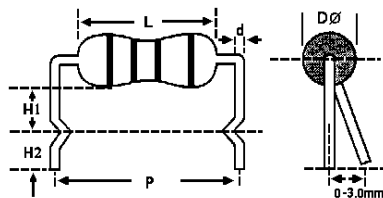

STYLE		DIMENSIONS (mm)					
NORMAL	MINIATURE	P	H1	H2	D	L	d
1W	1W	$15 \pm 1$	$6.0 \pm 1$	$5.0 \pm 1$	$4.5 \pm 0.5$	$11.5 \pm 1.0$	$0.78 \pm 0.03$
2W	3W	$20 \pm 1$	$10 \pm 1$	$5.0 \pm 1$	$5.0 \pm 0.5$	$15.5 \pm 1.0$	$0.78 \pm 0.03$

**F - TYPE**  
**FC - TYPE**

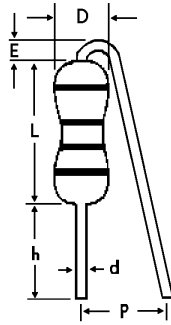

STYLE			DIMENSIONS (mm)					
	NORMAL	MINIATURE	P	h	D	L	d	E
F	1/4w	1/2w	10 ± 1	28 ± 2	2.3 ± 0.3	6.3 ± 0.5	0.55 ± 0.03	2 ± 0.5
FC	1/4w	1/2w	10 ± 1	8 ± 2	2.3 ± 0.3	6.3 ± 0.5	0.55 ± 0.03	2 ± 0.5

**FK - TYPE**  
**FCK - TYPE**

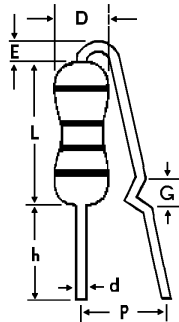

STYLE			DIMENSIONS (mm)						
	NORMAL	MINIATURE	P	h	G	D	L	d	E
FK	1/4W	1/2W	10 ± 1	28 ± 2	2 ± 0.5	2.3 ± 0.3	6.3 ± 0.5	0.55 ± 0.03	2 ± 0.5
FCK	1/4W	1/2W	10 ± 1	8	2 ± 0.5	2.3 ± 0.3	6.3 ± 0.5	0.55 ± 0.03	2 ± 0.5

**FKK - TYPE**

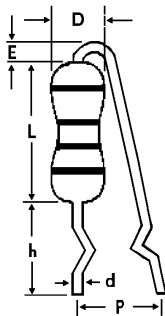

STYLE		DIMENSIONS (mm)				
NORMAL	MINIATURE	P	h	D	L	d
1/2W	1W	6 ± 1	10 ± 1	3.2 ± 0.5	9.0 ± 0.5	0.65 ± 0.03
1W	2W	6 ± 1	10 ± 1	4.5 ± 0.5	11.5 ± 1.0	0.78 ± 0.03
2W	3W	6 ± 1	10 ± 1	5.0 ± 0.5	15.5 ± 1.0	0.78 ± 0.03

NOTES:

---

NOTES:

---



NOTES:

---

### RESISTANCE COLOUR CODE

5%, 10%, 20% Banding

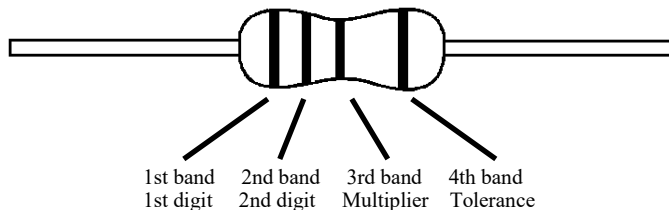

1%, 0.5%, 0.25%, 0.1% Banding

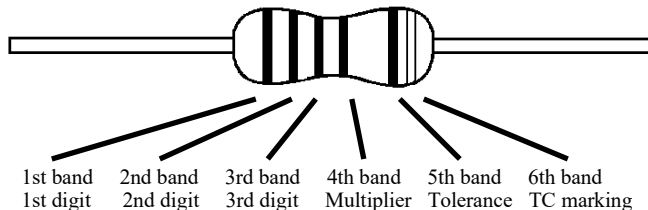

COLOUR	DIGIT	MULTIPLIER	TOLERANCE		TC MARKING—6th DIGIT	
Without			20%	M		
Silver		-100	10%	K		
Gold		-10	5%	J		
Black	0	1			200	G
Brown	1	10	1%	F	100	F
Red	2	100	2%	G	50	E
Orange	3	1K			15	C
Yellow	4	10K			25	D
Green	5	100K	0.5%	D		
Blue	6	1M	0.25%	C	10	B
Violet	7	10M	0.1%	B		
Grey	8	100M				
White	9					

### STANDARD RESISTANCE VALUES per TOLERANCE

0.1%	1%	2%	0.1%	1%	2%	0.1%	1%	2%	0.1%	1%	2%	0.1%	1%	2%	0.1%	1%	2%
.25%	5%	10%	.25%	5%	10%	.25%	5%	10%	.25%	5%	10%	.25%	5%	10%	.25%	5%	10%
10.0	10.0	10	14.7	14.7	-	21.5	21.5	-	31.6	31.6	-	46.4	46.4	-	68.1	68.1	68
10.1	-	-	14.9	-	-	21.8	-	-	32.0	-	-	47.0	-	47	69.0	-	-
10.2	10.2	-	15.0	15.0	15	22.1	22.1	22	32.4	32.4	-	47.5	47.5	-	69.8	69.8	-
10.4	-	-	15.2	-	-	22.3	-	-	32.8	-	-	48.1	-	-	70.6	-	-
10.5	10.5	-	15.4	15.4	-	22.6	22.6	-	33.2	33.2	33	48.7	48.7	-	71.5	71.5	-
10.6	-	-	15.6	-	-	22.9	-	-	33.6	-	-	49.3	-	-	72.3	-	-
10.7	10.7	-	15.8	15.8	-	23.2	23.2	-	34.0	34.0	-	49.9	49.9	-	73.2	73.2	-
10.9	-	-	16.0	-	16	23.4	-	-	34.4	-	-	50.5	-	-	74.1	-	-
11.0	11.0	11	16.2	16.2	-	23.7	23.7	-	34.8	34.8	-	51.1	51.1	51	75.0	75.0	75
11.1	-	-	16.4	-	-	24.0	-	24	35.2	-	-	51.7	-	-	75.9	-	-
11.3	11.3	-	16.5	16.5	-	24.3	24.3	-	35.7	35.7	-	52.3	52.3	-	76.8	76.8	-
11.4	-	-	16.7	-	-	24.6	-	-	36.1	-	36	53.0	-	-	77.7	-	-
11.5	11.5	-	16.9	16.9	-	24.9	24.9	-	36.5	36.5	-	53.6	53.6	-	78.7	78.7	-
11.7	-	-	17.2	-	-	25.2	-	-	37.0	-	-	54.2	-	-	79.6	-	-
11.8	11.8	-	17.4	17.4	-	25.5	25.5	-	37.4	37.4	-	54.9	54.9	-	80.6	80.6	-
12.0	-	12	17.6	-	-	25.8	-	-	37.9	-	-	55.6	-	-	81.6	-	-
12.1	12.1	-	17.8	17.8	-	26.1	26.1	-	38.3	38.3	-	56.2	56.2	56	82.5	82.5	82
12.3	-	-	18.0	-	18	26.4	-	-	38.8	-	-	56.9	-	-	83.5	-	-
12.4	12.4	-	18.2	18.2	-	26.7	26.7	-	39.2	39.2	39	57.6	57.6	-	84.5	84.5	-
12.6	-	-	18.4	-	-	27.1	-	27	39.7	-	-	58.3	-	-	85.6	-	-
12.7	12.7	-	18.7	18.7	-	27.4	27.4	-	40.2	40.2	-	59.0	59.0	-	86.6	86.6	-
12.9	-	-	18.9	-	-	27.7	-	-	40.7	-	-	59.7	-	-	87.6	-	-
13.0	13.0	13	19.1	19.1	-	28.0	28.0	-	41.2	41.2	-	60.4	60.4	-	88.7	88.7	-
13.2	-	-	19.3	-	-	28.4	-	-	41.7	-	-	61.2	-	-	89.8	-	-
13.3	13.3	-	19.6	19.6	-	28.7	28.7	-	42.2	42.2	-	61.9	61.9	62	90.9	90.9	91
13.5	-	-	19.8	-	-	29.1	-	-	42.7	-	-	62.6	-	-	92.0	-	-
13.7	13.7	-	20.0	20.0	20	29.4	29.4	-	43.2	43.2	43	63.4	63.4	-	93.1	93.1	-
13.8	-	-	20.3	-	-	29.8	-	-	43.7	-	-	64.2	-	-	94.2	-	-
14.0	14.0	-	20.5	20.5	-	30.1	30.1	30	44.2	44.2	-	64.9	64.9	-	95.3	95.3	-
14.2	-	-	20.8	-	-	30.5	-	-	44.8	-	-	65.7	-	-	96.5	-	-
14.3	14.3	-	21.0	21.0	-	30.9	30.9	-	45.3	45.3	-	66.5	66.5	-	97.6	97.6	-
14.5	-	-	21.3	-	-	31.2	-	-	45.9	-	-	67.3	-	-	98.8	-	-



**Head Office and Warehouse**

100 - 5118 North Fraser Way  
Burnaby, British Columbia, V5J 0H1  
Phone - 604-324-4811  
Fax - 604-324-3184  
E-Mail - [info@s-pintl.com](mailto:info@s-pintl.com)  
Web - [www.s-pintl.com](http://www.s-pintl.com)

**Eastern Sales Office**

200 - 550 Alden Road  
Markham, Ontario, L3R 6A8  
Phone - 905-475-5305  
Fax - 905-475-5462

Follow us on: [!\[\]\(cbe2492b119e39e02a1dab2af4a4b296\_img.jpg\)](#) [!\[\]\(2f36c159ea3670f7a62f64a4f1cf5c05\_img.jpg\)](#)